

Micropower, Single Supply Rail-to-Rail Output Instrumentation Amplifiers

FEATURES

- **Micropower: 95µA Supply Current Max**
- **Low Input Offset Voltage: 100µV Max**
- **Low Input Offset Voltage Drift: 0.5µV/°C Max**
- **Single Gain Set Resistor:**
 - G = 1 to 1000 (LT1789-1)**
 - G = 10 to 1000 (LT1789-10)**
- **Inputs Common Mode to V⁻**
- **Wide Supply Range: 2.2V to 36V Total Supply**
- **CMRR at G = 10: 96dB Min**
- **Gain Error: G = 10, 0.25% Max**
- **Gain Nonlinearity: G = 10, 40ppm Max**
- **Input Bias Current: 40nA Max**
- **PSRR at G = 10: 100dB Min**
- **1kHz Voltage Noise: 48nV/√Hz**
- **0.1Hz to 10Hz Noise: 1.5µV_{p-p}**

APPLICATIONS

- Portable Instrumentation
- Bridge Amplifiers
- Strain Gauge Amplifiers
- Thermocouple Amplifiers
- Differential to Single-Ended Converters
- Medical Instrumentation

DESCRIPTION

The LT[®]1789-1/LT1789-10 are micropower, precision instrumentation amplifiers that are optimized for single supply operation from 2.2V to 36V. The quiescent current is 95µA max, the inputs common mode to ground and the output swings within 110mV of ground. The gain is set with a single external resistor for a gain range of 1 to 1000 for the LT1789-1 and 10 to 1000 for the LT1789-10.

The high accuracy of the LT1789-1 (40ppm maximum nonlinearity and 0.25% max gain error) is unmatched by other micropower instrumentation amplifiers. The LT1789-10 maximizes both the input common mode range and dynamic output range when an amplification of 10 or greater is required, allowing precise signal processing where other instrumentation amplifiers fail to operate. The LT1789-1/LT1789-10 are laser trimmed for very low input offset voltage, low input offset voltage drift, high CMRR and high PSRR. The output can handle capacitive loads up to 400pF (LT1789-1), 1000pF (LT1789-10) in any gain configuration while the inputs are ESD protected up to 10kV (human body).

The LT1789-1/LT1789-10 are offered in the 8-pin SO package, requiring significantly less PC board area than discrete multi op amp and resistor designs.

 LTC and LT are registered trademarks of Linear Technology Corporation.

TYPICAL APPLICATION

0.5A to 4A Voltage Controlled Current Source

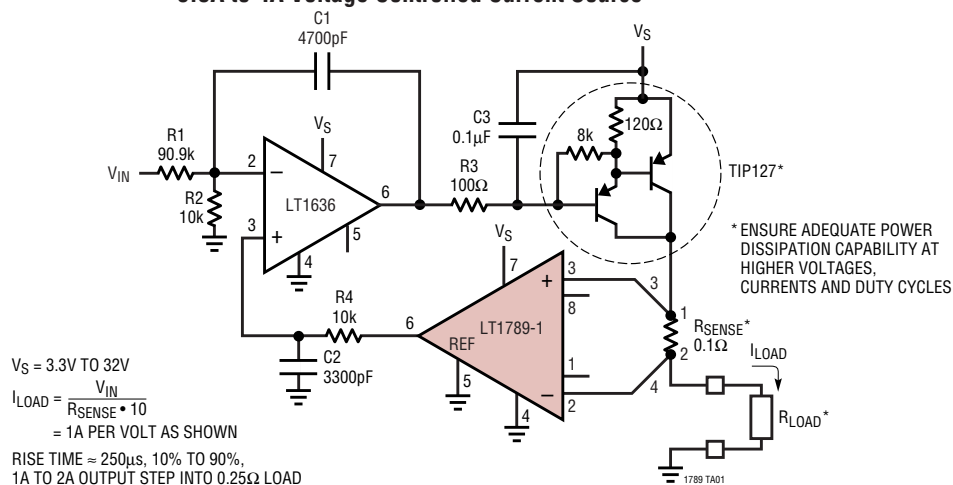

ABSOLUTE MAXIMUM RATINGS

(Note 1)

Supply Voltage (V^+ to V^-)	36V
Input Differential Voltage	36V
Input Current (Note 3)	$\pm 20\text{mA}$
Output Short-Circuit Duration	Indefinite
Operating Temperature Range	-40°C to 85°C
Specified Temperature Range (Note 4)	
LT1789C-1, LT1789C-10	-40°C to 85°C
LT1789I-1, LT1789I-10	-40°C to 85°C
Storage Temperature Range	-65°C to 150°C
Lead Temperature (Soldering, 10 sec)	300°C

PACKAGE/ORDER INFORMATION

	ORDER PART NUMBER
	LT1789CS8-1 LT1789IS8-1 LT1789CS8-10 LT1789IS8-10
	S8 PART MARKING
	17891 178911 178910 789110

Consult LTC Marketing for parts specified with wider operating temperature ranges.

3V and 5V ELECTRICAL CHARACTERISTICS

$V_S = 3\text{V}, 0\text{V}; V_S = 5\text{V}, 0\text{V}; R_L = 20\text{k}, V_{CM} = V_{REF} = \text{half supply}, T_A = 25^\circ\text{C}$, unless otherwise noted.

SYMBOL	PARAMETER	CONDITIONS	LT1789-1			LT1789-10			UNITS
			MIN	TYP	MAX	MIN	TYP	MAX	
G	Gain Range	LT1789-1, $G = 1 + (200\text{k}/R_G)$ LT1789-10, $G = 10 \cdot [1 + (200\text{k}/R_G)]$	1		1000			1000	
	Gain Error (Note 6)	$G = 1, V_0 = 0.1\text{V to } (+V_S) - 1\text{V}$		0.02	0.20				%
		LT1789-1, $V_0 = 0.1\text{V to } (+V_S) - 0.3\text{V}$ LT1789-10, $V_0 = 0.2\text{V to } (+V_S) - 0.3\text{V}$ $G = 10$, (Note 2)		0.06	0.25		0.01	0.25	%
		$G = 100$, (Note 2) $G = 1000$, (Note 2)		0.06	0.27		0.09	0.30	%
Gain Nonlinearity (Note 6)	$G = 1, V_0 = 0.1\text{V to } (+V_S) - 1\text{V}$		35		100				ppm
	LT1789-1, $V_0 = 0.1\text{V to } (+V_S) - 0.3\text{V}$ LT1789-10, $V_0 = 0.2\text{V to } 4.7\text{V}, V_S = 5\text{V}$ (Note 8)								
	$G = 10$ $G = 100$ $G = 1000$		12	40		15	100		ppm ppm ppm
V_{OST}	Total Input Referred Offset Voltage	$V_{OST} = V_{OSI} + V_{OSO}/G$							
V_{OSI}	Input Offset Voltage	$G = 1000$		15	100		20	160	μV
V_{OSO}	Output Offset Voltage	$G = 1$ (LT1789-1), $G = 10$ (LT1789-10)		150	750		650	3000	μV
I_{OS}	Input Offset Current	(Note 6)		0.2	4		0.2	4	nA
I_B	Input Bias Current	(Note 6)		19	40		19	40	nA
e_n	Input Noise Voltage, RTI (Referred to Input)	$G = 1, f_0 = 0.1\text{Hz to } 10\text{Hz}$		5.0					μV_{P-P}
		$G = 10$		1.5			4.6		μV_{P-P}
		$G = 100, 1000$		1.0			1.1		μV_{P-P}

3V and 5V ELECTRICAL CHARACTERISTICS

V_S = 3V, 0V; V_S = 5V, 0V; R_L = 20k, V_{CM} = V_{REF} = half supply, T_A = 25°C, unless otherwise noted.

SYMBOL	PARAMETER	CONDITIONS	LT1789-1			LT1789-10			UNITS	
			MIN	TYP	MAX	MIN	TYP	MAX		
Total RTI Noise = $\sqrt{e_{ni}^2 + (e_{no}/G)^2}$										
e _{ni}	Input Noise Voltage Density, RTI	f ₀ = 1kHz (Note 7)		48	85		52	90	nV/√Hz	
e _{no}	Output Noise Voltage Density, RTI	f ₀ = 1kHz (Note 3)		330			270		nV/√Hz	
i _n	Input Noise Current	f ₀ = 0.1Hz to 10Hz		16			16		pA _{p-p}	
	Input Noise Current Density	f ₀ = 1kHz		62			62		fA/√Hz	
R _{IN}	Input Resistance	V _{IN} = 0V to (+V _S) - 1V (Note 6)	0.75	1.6		0.75	1.6		GΩ	
C _{IN}	Input Capacitance	Differential Common Mode		1.6			1.6		pF	
				1.6			1.6		pF	
V _{CM}	Input Voltage Range		0		+V _S - 1	0		+V _S - 1.2	V	
CMRR	Common Mode Rejection Ratio	1k Source Imbalance, (Note 6) LT1789-1, V _{CM} = 0V to (+V _S) - 1V LT1789-10, V _{CM} = 0V to (+V _S) - 1.2V G = 1 G = 10 G = 100 G = 1000		79	88					dB
				96	106		88	105		dB
				100	114		98	113		dB
				100	114		98	113		dB
PSRR	Power Supply Rejection Ratio	V _S = 2.5V to 12.5V, V _{CM} = V _{REF} = 1V G = 1 G = 10 G = 100 G = 1000		90	100					dB
				100	113		94	109		dB
				102	116		102	120		dB
				102	116		102	120		dB
	Minimum Supply Voltage			2.2	2.5		2.2	2.5	V	
I _S	Supply Current	(Note 7)		67	95		67	95	μA	
V _{OL}	Output Voltage Swing LOW	(Note 7)		54	100		62	110	mV	
V _{OH}	Output Voltage Swing HIGH	(Note 7)	+V _S - 0.3	+V _S - 0.19		+V _S - 0.3	+V _S - 0.19		V	
I _{SC}	Short-Circuit Current	Short to GND		2.2			2.2		mA	
		Short to +V _S		8.5			8.5		mA	
BW	Bandwidth	G = 1		60					kHz	
		G = 10		30			25		kHz	
		G = 100		3			12		kHz	
		G = 1000		0.2			1.5		kHz	
SR	Slew Rate	G = 10, V _{OUT} = 0.5V to 4.5V		0.023			0.062		V/μs	
	Settling Time to 0.01%	4V Step		240			190		μs	
R _{REFIN}	Reference Input Resistance			220			220		kΩ	
I _{REFIN}	Reference Input Current	V _{REF} = 0V		2.7			2.7		μA	
AV _{REF}	Reference Gain to Output			1 ± 0.0001			1 ± 0.0001			

LT1789-1/LT1789-10

ELECTRICAL CHARACTERISTICS

The ● denotes the specifications which apply over the temperature range of $0^{\circ}\text{C} \leq T_A \leq 70^{\circ}\text{C}$. $V_S = 3\text{V}, 0\text{V}$; $V_S = 5\text{V}, 0\text{V}$; $R_L = 20\text{k}$, $V_{\text{REF}} = \text{half supply}$, unless otherwise noted. (Note 4)

SYMBOL	PARAMETER	CONDITIONS	LT1789-1			LT1789-10			UNITS
			MIN	TYP	MAX	MIN	TYP	MAX	
	Gain Error (Note 6)	$G = 1, V_O = 0.3\text{V to } (+V_S) - 1\text{V}$ ●			0.25				%
		$V_O = 0.3\text{V to } (+V_S) - 0.5\text{V}$							
		$G = 10$ (Note 2) ● $G = 100$ (Note 2) ●			0.53 0.55		0.30 0.53		% %
	Gain Nonlinearity (Note 6)	$G = 1, V_O = 0.3\text{V to } (+V_S) - 1\text{V}$ ●			185				ppm
		LT1789-1, $V_O = 0.3\text{V to } (+V_S) - 0.5\text{V}$ LT1789-10, $V_O = 0.3\text{V to } 4.7\text{V}, V_S = 5\text{V}$ (Note 8)							
		$G = 10$ ● $G = 100$ ●			90 120		130 130		ppm ppm
G/T	Gain vs Temperature	$G < 1000$ (Notes 2, 3) ●		5	50		5	50	ppm/ $^{\circ}\text{C}$
V_{OST}	Total Input Referred Offset Voltage $V_{\text{OST}} = V_{\text{OSI}} + V_{\text{OSO}}/G$								
V_{OSI}	Input Offset Voltage	$G = 1000$ ●			150			190	μV
V_{OSIH}	Input Offset Voltage Hysteresis	(Notes 3, 5) ●		3	10		3	10	μV
V_{OSO}	Output Offset Voltage	$G = 1$ (LT1789-1), $G = 10$ (LT1789-10) ●			950			3700	μV
V_{OSOH}	Output Offset Voltage Hysteresis	(Notes 3, 5) ●		50	100		300	900	μV
V_{OSI}/T	Input Offset Voltage Drift (RTI)	(Note 3) ●		0.2	0.5		0.3	0.7	$\mu\text{V}/^{\circ}\text{C}$
V_{OSO}/T	Output Offset Voltage Drift	(Note 3) ●		1.5	4		7	20	$\mu\text{V}/^{\circ}\text{C}$
I_{OS}	Input Offset Current	(Note 6) ●			4.5			4.5	nA
I_{OS}/T	Input Offset Current Drift	●		3			3		$\text{pA}/^{\circ}\text{C}$
I_{B}	Input Bias Current	(Note 6) ●			45			45	nA
I_{B}/T	Input Bias Current Drift	●		50			50		$\text{pA}/^{\circ}\text{C}$
V_{CM}	Input Voltage Range	●	0.2		$(+V_S) - 1$	0.2		$(+V_S) - 1.5$	V
CMRR	Common Mode Rejection Ratio	1k Source Imbalance, (Note 6)							
		LT1789-1, $V_{\text{CM}} = 0.2\text{V to } (+V_S) - 1\text{V}$							
		LT1789-10, $V_{\text{CM}} = 0.2\text{V to } (+V_S) - 1.5\text{V}$							
		$G = 1$ ● $G = 10$ ● $G = 100, 1000$ ●		77 94 98		85 96			dB dB dB
PSRR	Power Supply Rejection Ratio	$V_S = 2.5\text{V to } 12.5\text{V}, V_{\text{CM}} = V_{\text{REF}} = 1\text{V}$							
		$G = 1$ ●		88					dB
		$G = 10$ ●		98		92			dB
		$G = 100, 1000$ ●		100		100			dB
	Minimum Supply Voltage	●			2.5			2.5	V
I_{S}	Supply Current	(Note 7) ●			115			115	μA
V_{OL}	Output Voltage Swing LOW	(Note 7) ●			110			120	mV
V_{OH}	Output Voltage Swing HIGH	(Note 7) ●	$+V_S - 0.38$				$+V_S - 0.38$		V

ELECTRICAL CHARACTERISTICS The ● denotes the specifications which apply over the temperature range of $-40^{\circ}\text{C} \leq T_A \leq 85^{\circ}\text{C}$. $V_S = 3\text{V}, 0\text{V}; V_S = 5\text{V}, 0\text{V}; R_L = 20\text{k}, V_{\text{REF}} = \text{half supply}$, unless otherwise noted. (Note 4)

SYMBOL	PARAMETER	CONDITIONS	LT1789-1			LT1789-10			UNITS
			MIN	TYP	MAX	MIN	TYP	MAX	
	Gain Error (Note 6)	$G = 1, V_O = +0.3\text{V to } (+V_S) - 1\text{V}$ ●			0.30				%
		$V_O = 0.3\text{V to } (+V_S) - 0.5\text{V}$							
		$G = 10$ (Note 2) ● $G = 100$ (Note 2) ●			0.57 0.59		0.35 0.62		% %
	Gain Nonlinearity (Note 6)	$G = 1, V_O = 0.3\text{V to } (+V_S) - 1\text{V}$ ●			250				ppm
		LT1789-1, $V_O = 0.3\text{V to } (+V_S) - 0.5\text{V}$ LT1789-10, $V_O = 0.3\text{V to } 4.7\text{V}, V_S = 5\text{V}$ (Note 8)							
		$G = 10$ ● $G = 100$ ●			105 160		150 170		ppm ppm
G/T	Gain vs Temperature	$G < 1000$ (Notes 2, 3)			5	50	5	50	ppm/ $^{\circ}\text{C}$
V_{OST}	Total Input Referred Offset Voltage $V_{\text{OST}} = V_{\text{OSI}} + V_{\text{OSO}}/G$								
V_{OSI}	Input Offset Voltage	$G = 1000$	●		175		205		μV
V_{OSIH}	Input Offset Voltage Hysteresis	(Notes 3, 5)	●		3	10	3	10	μV
V_{OSO}	Output Offset Voltage	$G = 1$ (LT1789-1), $G = 10$ (LT1789-10)	●			1050		4000	μV
V_{OSOH}	Output Offset Voltage Hysteresis	(Notes 3, 5)	●		50	100	300	900	μV
V_{OSI}/T	Input Offset Voltage Drift (RTI)	(Note 3)	●		0.2	0.5	0.3	0.7	$\mu\text{V}/^{\circ}\text{C}$
V_{OSO}/T	Output Offset Voltage Drift	(Note 3)	●		1.5	4	7	20	$\mu\text{V}/^{\circ}\text{C}$
I_{OS}	Input Offset Current	(Note 6)	●			5		5	nA
I_{OS}/T	Input Offset Current Drift		●		3		3		$\text{pA}/^{\circ}\text{C}$
I_{B}	Input Bias Current	(Note 6)	●			50		50	nA
I_{B}/T	Input Bias Current Drift		●		50		50		$\text{pA}/^{\circ}\text{C}$
V_{CM}	Input Voltage Range		●	0.2		$+V_S - 1$	0.2	$+V_S - 1.5$	V
CMRR	Common Mode Rejection Ratio	1k Source Imbalance, (Note 6)							
		LT1789-1 $V_{\text{CM}} = 0.2\text{V to } (+V_S) - 1\text{V}$	●	75					dB
		LT1789-10 $V_{\text{CM}} = 0.2\text{V to } (+V_S) - 1.5\text{V}$	●	92		84			dB
		$G = 1$ ● $G = 10$ ● $G = 100, 1000$ ●		96		94			dB
PSRR	Power Supply Rejection Ratio	$V_S = 2.5\text{V to } 12.5\text{V}, V_{\text{CM}} = V_{\text{REF}} = 1\text{V}$							
		$G = 1$ ●	86					dB	
		$G = 10$ ●	96		90			dB	
		$G = 100, 1000$ ●	98		98			dB	
	Minimum Supply Voltage		●		2.5		2.5		V
I_{S}	Supply Current	(Note 7)	●		125		125		μA
V_{OL}	Output Voltage Swing LOW	(Note 7)	●		120		130		mV
V_{OH}	Output Voltage Swing HIGH	(Note 7)	●	$+V_S - 0.40$			$+V_S - 0.40$		V

ELECTRICAL CHARACTERISTICS

$V_S = \pm 15V$, $R_L = 20k$, $V_{CM} = V_{OUT} = 0V$, $T_A = 25^\circ C$, unless otherwise noted.

SYMBOL	PARAMETER	CONDITIONS	LT1789-1			LT1789-10			UNITS		
			MIN	TYP	MAX	MIN	TYP	MAX			
G	Gain Range	LT1789-1, $G = 1 + (200k/R_G)$ LT1789-10, $G = 10 \cdot [1 + (200k/R_G)]$	1		1000			10		1000	
	Gain Error	$V_O = \pm 10V$ $G = 1$ $G = 10$ (Note 2) $G = 100$ (Note 2) $G = 1000$ (Note 2)		0.01	0.10						%
				0.04	0.15		0.01	0.15		%	
			0.04	0.15		0.03	0.20		%		
			0.07	0.20		0.03	0.25		%		
	Gain Nonlinearity	$V_O = \pm 10V$ $G = 1$ $G = 10$ $G = 100$ $G = 1000$		8	20						ppm
				1	10		5	40		ppm	
				6	20		5	40		ppm	
				20	100		25	160		ppm	
V_{OST}	Total Input Referred Offset Voltage $V_{OST} = V_{OSI} + V_{OSO}/G$										
V_{OSI}	Input Offset Voltage	$G = 1000$		30	235		30	295			μV
V_{OSO}	Output Offset Voltage	$G = 1$ (LT1789-1), $G = 10$ (LT1789-10)		200	1		0.6	3.3			mV
I_{OS}	Input Offset Current			0.2	4		0.2	4			nA
I_B	Input Bias Current			17	40		17	40			nA
e_n	Input Noise Voltage, RTI	$f_0 = 0.1Hz$ to 10Hz $G = 1$ $G = 10$ $G = 100, 1000$									μV_{p-p}
					5.0						μV_{p-p}
					1.5		4.6				μV_{p-p}
					1.0		1.1				μV_{p-p}
Total RTI Noise = $\sqrt{e_{ni}^2 + (e_{no}/G)^2}$											
e_{ni}	Input Noise Voltage Density, RTI	$f_0 = 1kHz$		49	90		53	95			nV/ \sqrt{Hz}
e_{no}	Output Noise Voltage Density, RTI	$f_0 = 1kHz$		330			270				nV/ \sqrt{Hz}
i_n	Input Noise Current	$f_0 = 0.1Hz$ to 10Hz		19			19				pA $_{p-p}$
	Input Noise Current Density	$f_0 = 1kHz$		100			62				pA/ \sqrt{Hz}
R_{IN}	Input Resistance		2	4.7		2	4.7				G Ω
C_{IN}	Input Capacitance	Differential		20			20				pF
		Common Mode		17			17				pF
V_{CM}	Input Voltage Range		-15		14	-15		14			V
CMRR	Common Mode Rejection Ratio	1k Source Imbalance, $V_{CM} = -15V$ to 14V $G = 1$ $G = 10$ $G = 100, 1000$		80	89						dB
				98	108		93	108			dB
				102	117		102	123			dB
PSRR	Power Supply Rejection Ratio	LT1789-1, $V_S = \pm 1.25V$ to $\pm 16V$ LT1789-10, $V_S = \pm 1.50V$ to $\pm 16V$ $G = 1$ $G = 10$ $G = 100, 1000$		94	107						dB
				104	118		100	115			dB
				106	121		106	129			dB
	Minimum Supply Voltage				± 1.25			± 1.50			V
I_S	Supply Current			85	130		85	130			μA
V_O	Output Voltage Swing		± 14.5	± 14.7		± 14.5	± 14.7				V
I_{SC}	Short-Circuit Current	Short to $-V_S$		2.2			2.2				mA
		Short to $+V_S$		8.5			8.5				mA

ELECTRICAL CHARACTERISTICS

$V_S = \pm 15V$, $R_L = 20k$, $V_{CM} = V_{OUT} = 0V$, $T_A = 25^\circ C$, unless otherwise noted.

SYMBOL	PARAMETER	CONDITIONS	LT1789-1			LT1789-10			UNITS
			MIN	TYP	MAX	MIN	TYP	MAX	
BW	Bandwidth	$G = 1$		60				kHz	
		$G = 10$		30		25		kHz	
		$G = 100$		3		12		kHz	
		$G = 1000$		0.2		1.5		kHz	
SR	Slew Rate	$V_{OUT} = \pm 10V$	0.012	0.026		0.028	0.066	$V/\mu s$	
	Settling Time to 0.01%	10V Step		460			270	μs	
R_{REFIN}	Reference Input Resistance			220			220	$k\Omega$	
I_{REFIN}	Reference Input Current	$V_{REF} = 0$		2.7			2.7	μA	
AV_{REF}	Reference Gain to Output			1 ± 0.0001			1 ± 0.0001		

The ● denotes the specifications which apply over the temperature range of $0^\circ C \leq T_A \leq 70^\circ C$. $V_S = \pm 15V$, $R_L = 20k$, $V_{CM} = V_{REF} = 0V$, unless otherwise noted. (Note 4)

SYMBOL	PARAMETER	CONDITIONS		LT1789-1			LT1789-10			UNITS	
				MIN	TYP	MAX	MIN	TYP	MAX		
	Gain Error	$V_O = \pm 10V$									
		$G = 1$	●					0.15	%		
		$G = 10$ (Note 2)	●					0.38	0.20	%	
		$G = 100$ (Note 2)	●					0.38	0.43	%	
		$G = 1000$ (Note 2)	●					0.43	0.48	%	
	Gain Nonlinearity	$V_O = \pm 10V$									
		$G = 1$	●					25	ppm		
		$G = 10$	●					15	45	ppm	
		$G = 100$	●					25	45	ppm	
		$G = 1000$	●					120	180	ppm	
G/T	Gain vs Temperature	$G < 1000$ (Notes 2, 3)	●		5	50		5	50	ppm/ $^\circ C$	
V_{OST}	Total Input Referred Offset Voltage $V_{OST} = V_{OSI} + V_{OSO}/G$										
V_{OSI}	Input Offset Voltage	$G = 1000$	●			285			325	μV	
V_{OSIH}	Input Offset Voltage Hysteresis	(Notes 3, 5)	●		8	30		8	30	μV	
V_{OSO}	Output Offset Voltage	$G = 1$	●			1.2			4	mV	
V_{OSOH}	Output Offset Voltage Hysteresis	(Notes 3, 5)	●		50	120		400	1000	μV	
V_{OSI}/T	Input Offset Voltage Drift (RTI)	(Note 3)	●		0.2	0.7		0.3	0.8	$\mu V/^\circ C$	
V_{OSO}/T	Output Offset Voltage Drift	(Note 3)	●		1.5	5		8	22	$\mu V/^\circ C$	
I_{OS}	Input Offset Current		●			4.5			4.5	nA	
I_{OS}/T	Input Offset Current Drift		●			2			2	$pA/^\circ C$	
I_B	Input Bias Current		●			45			45	nA	
I_B/T	Input Bias Current Drift		●			35			35	$pA/^\circ C$	
V_{CM}	Input Voltage Range	$G = 1$, Other Input Grounded	●	-14.8		14		-14.8		14	V
CMRR	Common Mode Rejection Ratio	1k Source Imbalance, $V_{CM} = -14.8V$ to $14V$									
		$G = 1$	●		78					dB	
		$G = 10$	●		96			91		dB	
		$G = 100, 1000$	●		100			100		dB	

LT1789-1/LT1789-10

ELECTRICAL CHARACTERISTICS

The ● denotes the specifications which apply over the temperature range of $0^{\circ}\text{C} \leq T_A \leq 70^{\circ}\text{C}$. $V_S = \pm 15\text{V}$, $R_L = 20\text{k}$, $V_{CM} = V_{REF} = 0\text{V}$, unless otherwise noted. (Note 4)

SYMBOL	PARAMETER	CONDITIONS	LT1789-1			LT1789-10			UNITS
			MIN	TYP	MAX	MIN	TYP	MAX	
PSRR	Power Supply Rejection Ratio	LT1789-1, $V_S = \pm 1.25\text{V}$ to $\pm 16\text{V}$							
		LT1789-10, $V_S = \pm 1.50\text{V}$ to $\pm 16\text{V}$							
		$G = 1$	●	92					dB
		$G = 10$	●	102		98		dB	
		$G = 100, 1000$	●	104		104		dB	
	Minimum Supply Voltage		●		± 1.25		± 1.50	V	
I_S	Supply Current		●		150		150	μA	
V_O	Output Voltage Swing		●	± 14.25		± 14.25		V	
SR	Slew Rate	$V_{OUT} = \pm 10\text{V}$	●	0.010		0.026		$\text{V}/\mu\text{s}$	

The ● denotes the specifications which apply over the temperature range of $-40^{\circ}\text{C} \leq T_A \leq 85^{\circ}\text{C}$. $V_S = \pm 15\text{V}$, $R_L = 20\text{k}$, $V_{CM} = V_{REF} = 0\text{V}$, unless otherwise noted. (Note 4)

SYMBOL	PARAMETER	CONDITIONS	LT1789-1			LT1789-10			UNITS
			MIN	TYP	MAX	MIN	TYP	MAX	
	Gain Error	$V_O = \pm 10\text{V}$							
		$G = 1$	●		0.20				%
		$G = 10$ (Note 2)	●		0.57		0.25		%
		$G = 100$ (Note 2)	●		0.57		0.62		%
		$G = 1000$ (Note 2)	●		0.62		0.67	%	
	Gain Nonlinearity	$V_O = \pm 10\text{V}$							
		$G = 1$	●		30				ppm
		$G = 10$	●		20		50		ppm
		$G = 100$	●		30		50		ppm
		$G = 1000$	●		130		200	ppm	
G/T	Gain vs Temperature	$G < 1000$ (Notes 2, 3)	●	5	50		5	50	$\text{ppm}/^{\circ}\text{C}$
V_{OST}	Total Input Referred Offset Voltage $V_{OST} = V_{OSI} + V_{OSO}/G$								
V_{OSI}	Input Offset Voltage	$G = 1000$	●		305		340		μV
V_{OSIH}	Input Offset Voltage Hysteresis	(Notes 3, 5)	●	8	30		8	30	μV
V_{OSO}	Output Offset Voltage	$G = 1$	●		1.3		4.2		mV
V_{OSOH}	Output Offset Voltage Hysteresis	(Notes 3, 5)	●	50	120		400	1000	μV
V_{OSI}/T	Input Offset Voltage Drift (RTI)	(Note 3)	●	0.2	0.7		0.3	0.8	$\mu\text{V}/^{\circ}\text{C}$
V_{OSO}/T	Output Offset Voltage Drift	(Note 3)	●	1.5	5		8	22	$\mu\text{V}/^{\circ}\text{C}$
I_{OS}	Input Offset Current		●		5		5		nA
I_{OS}/T	Input Offset Current Drift		●	2			2		$\text{pA}/^{\circ}\text{C}$
I_B	Input Bias Current		●		50		50		nA
I_B/T	Input Bias Current Drift		●	35			35		$\text{pA}/^{\circ}\text{C}$
V_{CM}	Input Voltage Range	$G = 1$, Other Input Grounded	●	-14.8	14		-14.8	14	V
CMRR	Common Mode Rejection Ratio	1k Source Imbalance, $V_{CM} = -14.8\text{V}$ to 14V							
		$G = 1$	●	76					dB
		$G = 10$	●	94		89			dB
		$G = 100, 1000$	●	98		98		dB	

ELECTRICAL CHARACTERISTICS

The ● denotes the specifications which apply over the temperature range of $-40^{\circ}\text{C} \leq T_A \leq 85^{\circ}\text{C}$. $V_S = \pm 15\text{V}$, $R_L = 20\text{k}$, $V_{CM} = V_{REF} = 0\text{V}$, unless otherwise noted. (Note 4)

SYMBOL	PARAMETER	CONDITIONS	LT1789-1			LT1789-10			UNITS
			MIN	TYP	MAX	MIN	TYP	MAX	
PSRR	Power Supply Rejection Ratio	LT1789-1, $V_S = \pm 1.25\text{V}$ to $\pm 16\text{V}$ LT1789-10, $V_S = \pm 1.50\text{V}$ to $\pm 16\text{V}$ $G = 1$ $G = 10$ $G = 100, 1000$	●	90					dB
			●	100		96			dB
			●	102		102			dB
	Minimum Supply Voltage		●		± 1.25		± 1.50	V	
I_S	Supply Current		●		160		160	μA	
V_O	Output Voltage Swing		●	± 14.15		± 14.15		V	
SR	Slew Rate	$V_{OUT} = \pm 10\text{V}$	●	0.008		0.024		$\text{V}/\mu\text{s}$	

Note 1: Absolute Maximum Ratings are those values beyond which the life of a device may be impaired.

Note 2: Does not include the effect of the external gain resistor R_G .

Note 3: This parameter is not 100% tested.

Note 4: The LT1789C-1/ LT1789C-10 is guaranteed to meet specified performance from 0°C to 70°C and is designed, characterized and expected to meet these extended temperature limits, but is not tested at -40°C and 85°C . The LT1789I-1/ LT1789I-10 is guaranteed to meet the extended temperature limits.

Note 5: Hysteresis in offset voltage is created by package stress that differs depending on whether the IC was previously at a higher or lower temperature. Offset voltage hysteresis is always measured at 25°C , but the IC is cycled to 85°C I-grade (or 70°C C-grade) or -40°C I-grade (0°C C-grade) before successive measurement. 60% of the parts will pass the typical limit on the data sheet.

Note 6: $V_S = 5\text{V}$ limits are guaranteed by correlation to $V_S = 3\text{V}$ and $V_S = \pm 15\text{V}$ tests.

Note 7: $V_S = 3\text{V}$ limits are guaranteed by correlation to $V_S = 5\text{V}$ and $V_S = \pm 15\text{V}$ tests.

Note 8: This parameter is not tested at $V_S = 3\text{V}$ on the LT1789-10 due to an increase in sensitivity to test system noise. Actual performance is expected to be similar to performance at $V_S = 5\text{V}$.

TYPICAL PERFORMANCE CHARACTERISTICS (LT1789-1, LT1789-10)

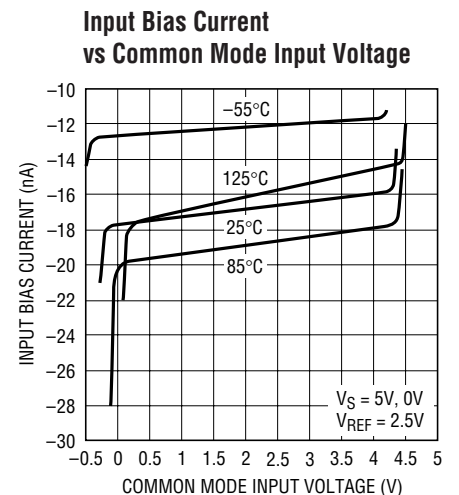
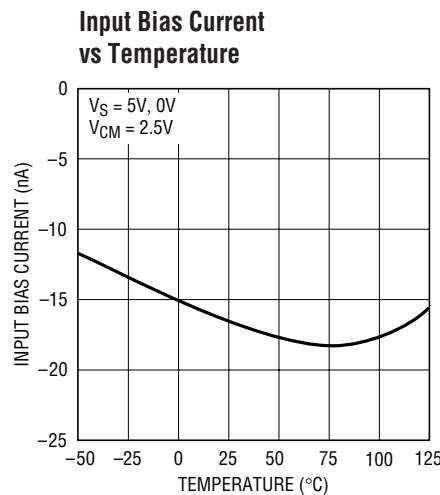
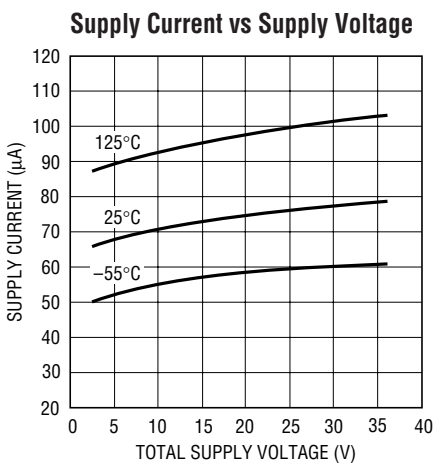

TYPICAL PERFORMANCE CHARACTERISTICS (LT1789-1)

Output Voltage Swing vs Load Current

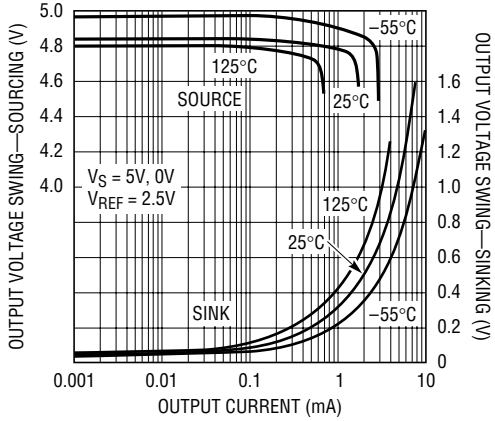

1789 G04

Gain vs Frequency

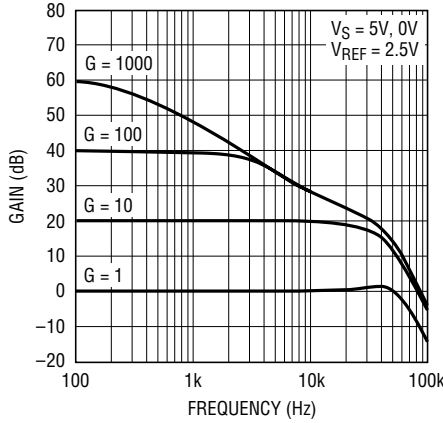

1789 G05

Slew Rate vs Temperature

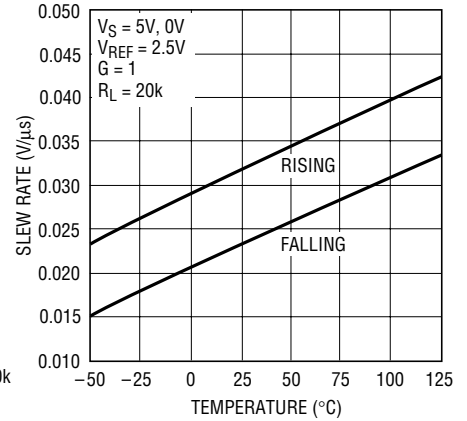

1789 G06

Common Mode Rejection Ratio vs Frequency

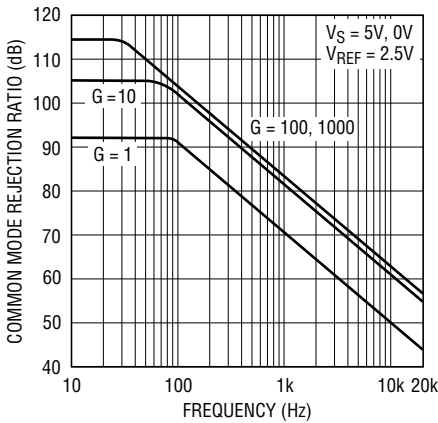

1879 G07

Negative Power Supply Rejection Ratio vs Frequency

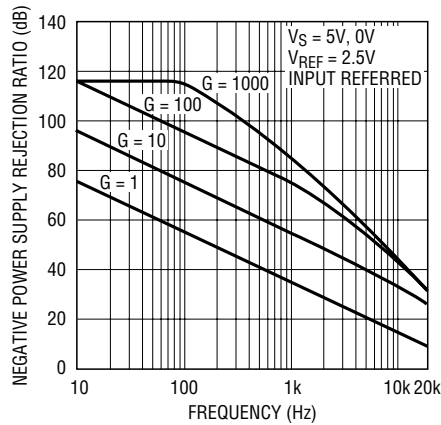

1789 G08

Positive Power Supply Rejection Ratio vs Frequency

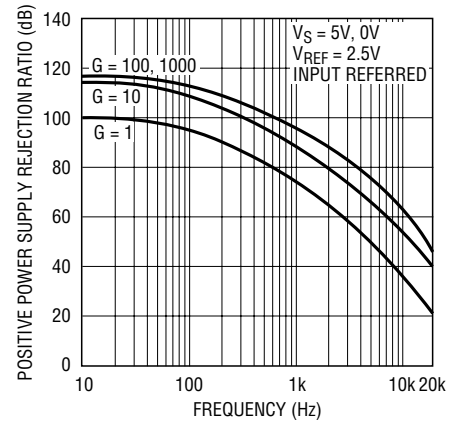

1789 G09

Output Impedance vs Frequency

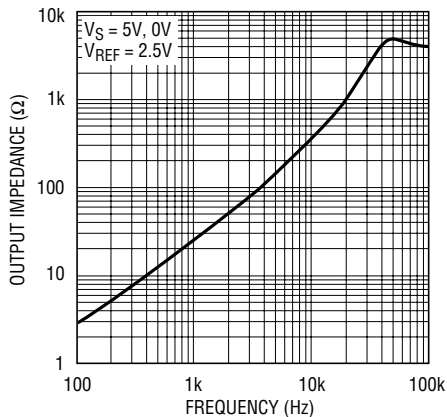

1789 G10

Overshoot vs Capacitive Load

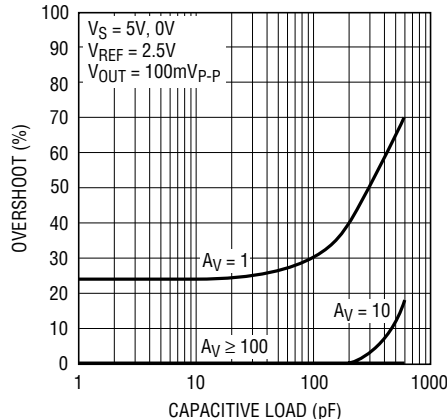

1789 G11

Settling Time to 0.01% vs Output Step

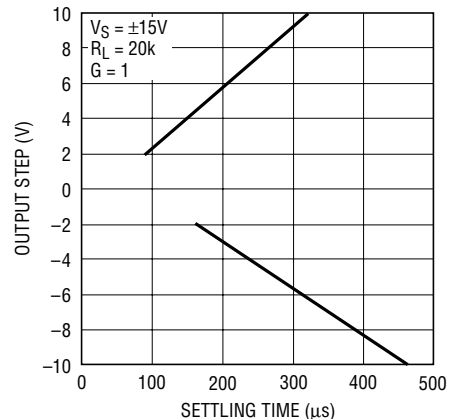

1789 G12

TYPICAL PERFORMANCE CHARACTERISTICS (LT1789-1)

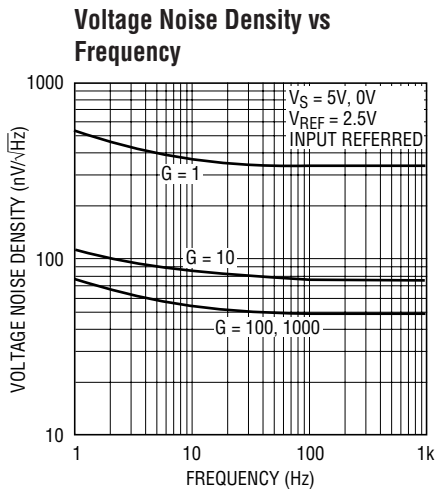

1789 G13

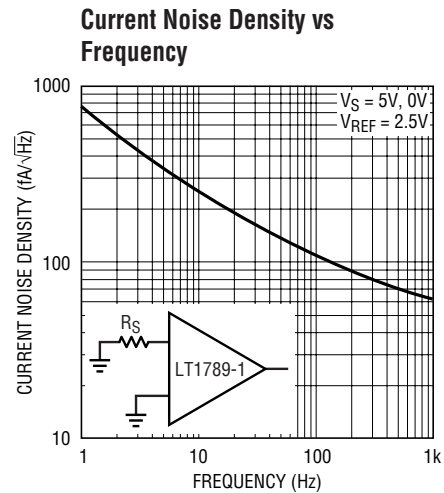

1789 G14

0.1Hz to 10Hz Noise Voltage, G = 1

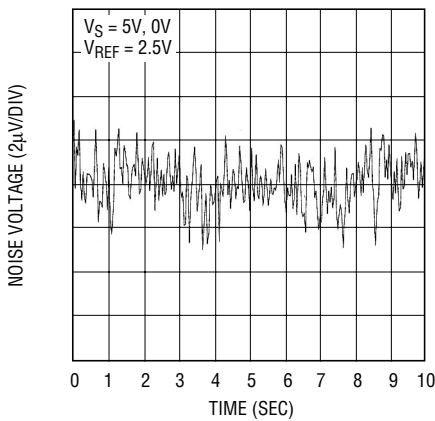

1789 G15

0.1Hz to 10Hz Noise Voltage, RTI, G = 1000

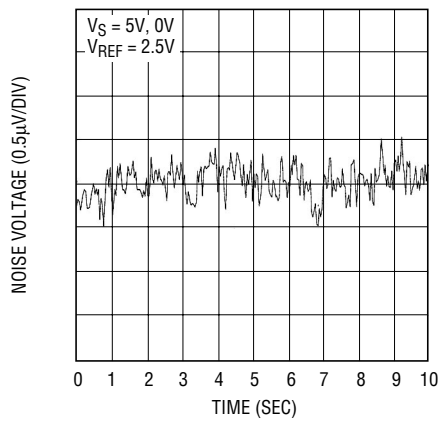

1789 G16

0.1Hz to 10Hz Noise Current

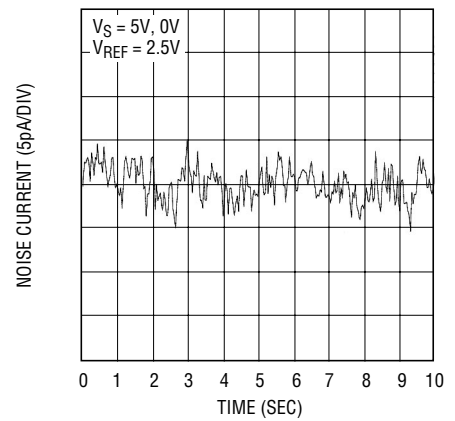

1789 G17

Turn-On Characteristics

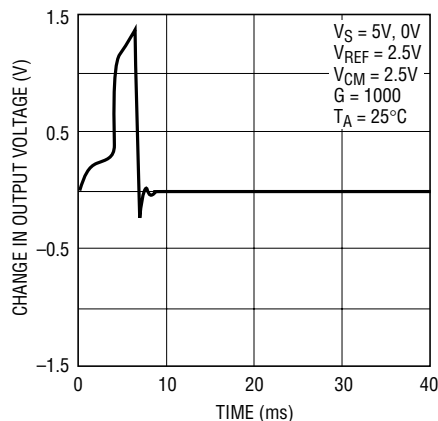

1789 G18

TYPICAL PERFORMANCE CHARACTERISTICS (LT1789-10)

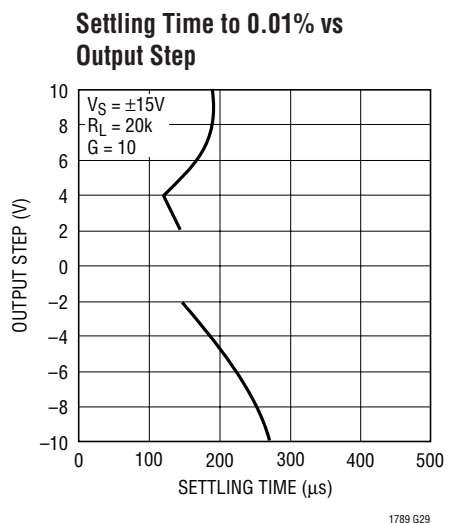
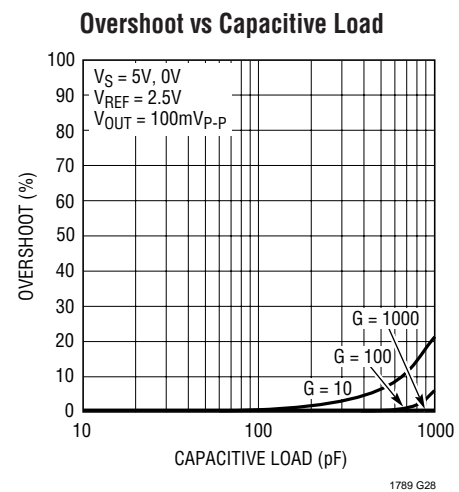
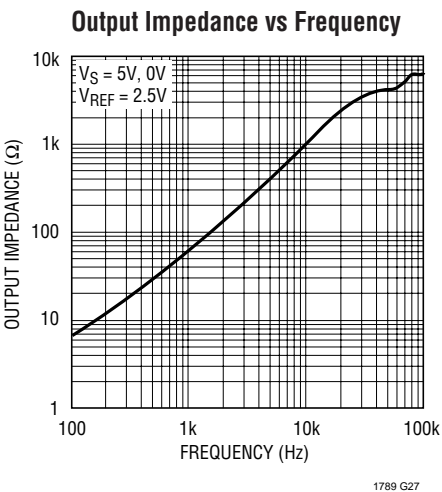
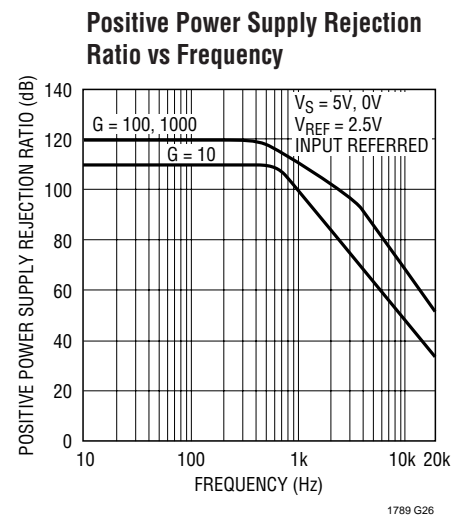
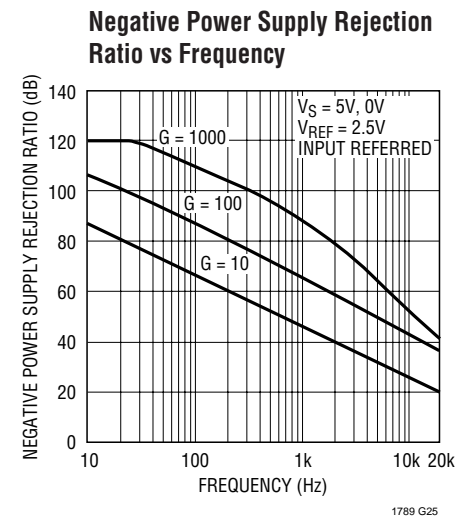
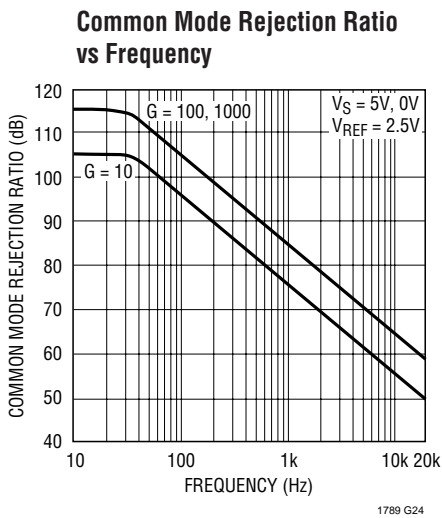
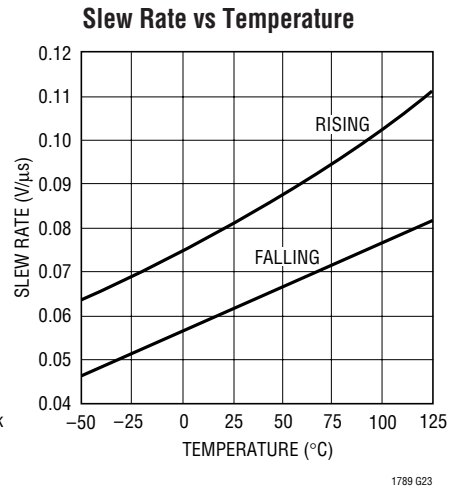
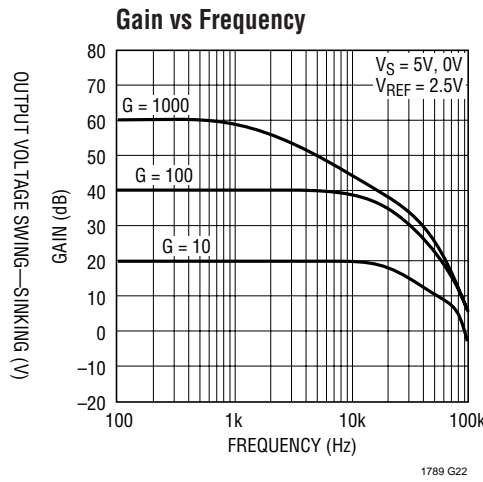
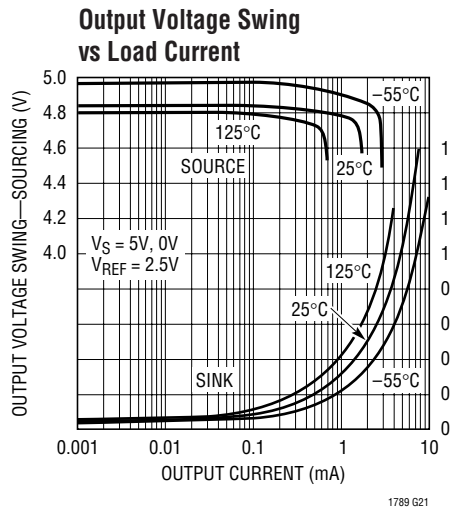

TYPICAL PERFORMANCE CHARACTERISTICS (LT1789-10)

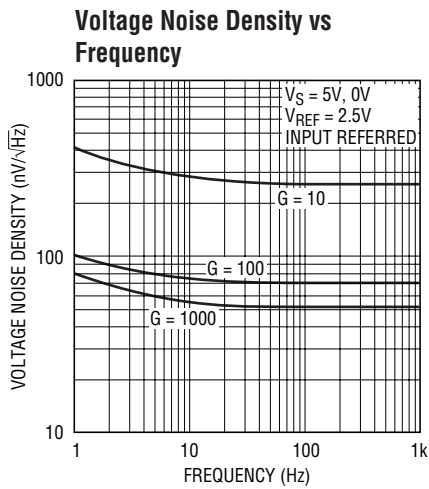

1789 G30

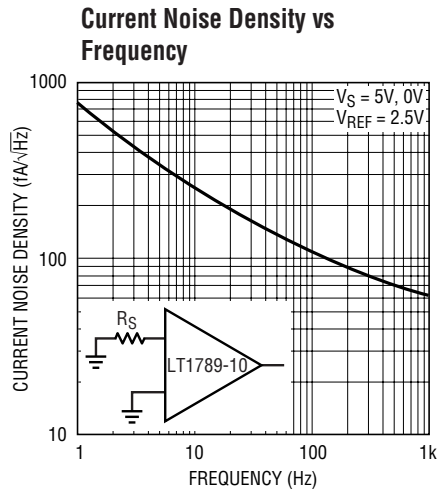

1789 G31

0.1Hz to 10Hz Noise Voltage, RTI, $G = 10$

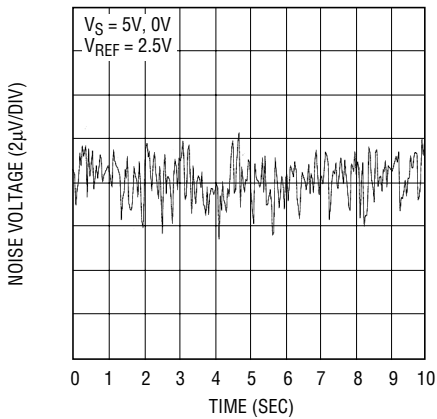

1789 G32

0.1Hz to 10Hz Noise Voltage, RTI, $G = 1000$

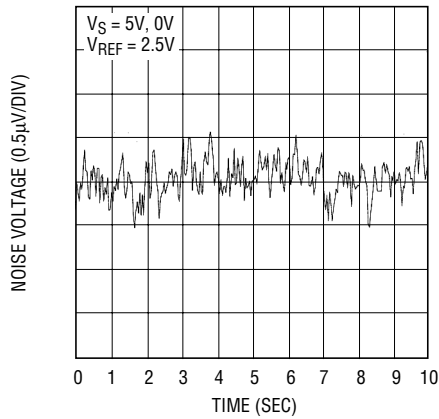

1789 G33

0.1Hz to 10Hz Noise Current

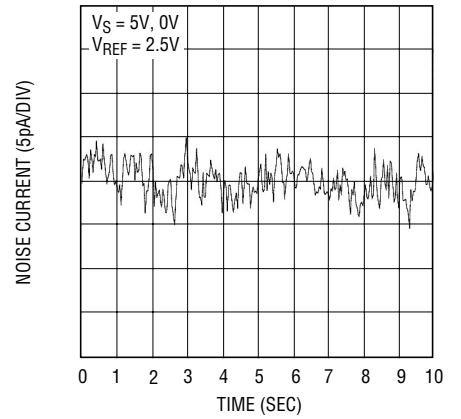

1789 G34

Turn-On Characteristics

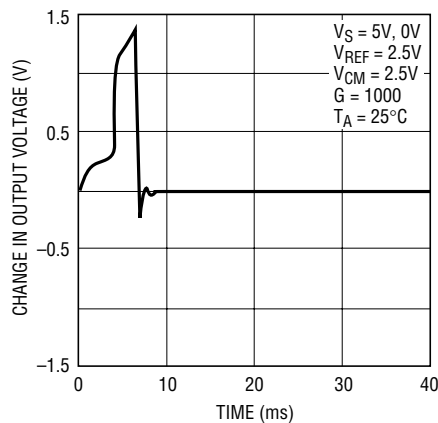

1789 G18

TYPICAL PERFORMANCE CHARACTERISTICS (LT1789-1)

Large-Signal Transient Response
G = 1, 10, 100

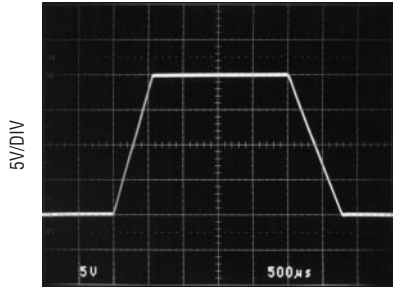

$V_S = \pm 15V$
 $R_L = 20k$
 $C_L = 50pF$
 500µs/DIV 1789-1 G38

Large-Signal Transient Response
G = 1000

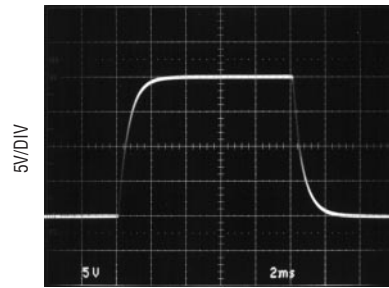

$V_S = \pm 15V$
 $R_L = 20k$
 $C_L = 50pF$
 2ms/DIV 1789-1 G39

Small-Signal Transient Response
G = 1

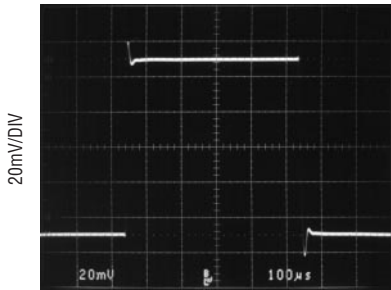

$V_S = 5V, 0V$
 $V_{REF} = 2.5V$
 $R_L = 20k$
 $C_L = 50pF$
 100µs/DIV 1789-1 G40

Small-Signal Transient Response
G = 10

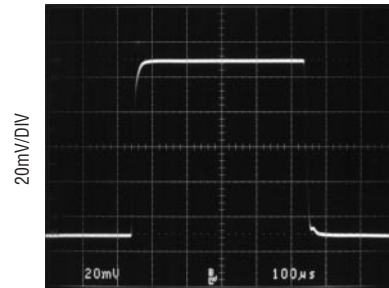

$V_S = 5V, 0V$
 $V_{REF} = 2.5V$
 $R_L = 20k$
 $C_L = 50pF$
 100µs/DIV 1789-1 G41

Small-Signal Transient Response
G = 100

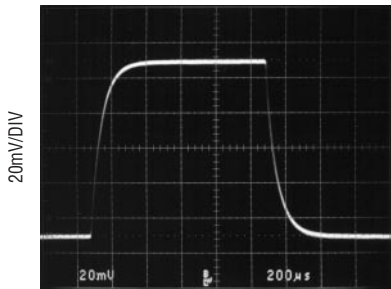

$V_S = 5V, 0V$
 $V_{REF} = 2.5V$
 $R_L = 20k$
 $C_L = 50pF$
 200µs/DIV 1789-1 G42

Small-Signal Transient Response
G = 1000

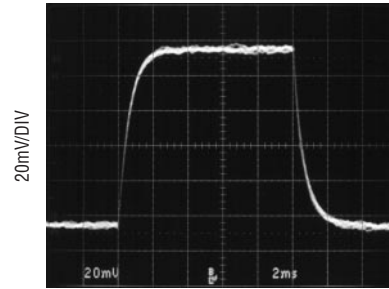

$V_S = 5V, 0V$
 $V_{REF} = 2.5V$
 $R_L = 20k$
 $C_L = 50pF$
 2ms/DIV 1789-1 G43

TYPICAL PERFORMANCE CHARACTERISTICS (LT1789-10)

Large-Signal Transient Response
G = 10, 100

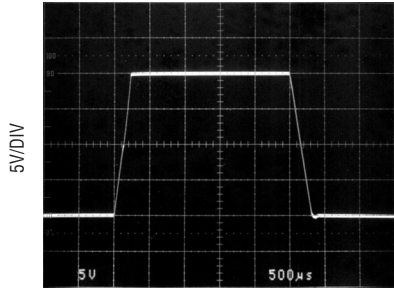

$V_S = \pm 15V$
 $R_L = 20k$
 $C_L = 50pF$
 500µs/DIV 1789-10 G44

Large-Signal Transient Response
G = 1000

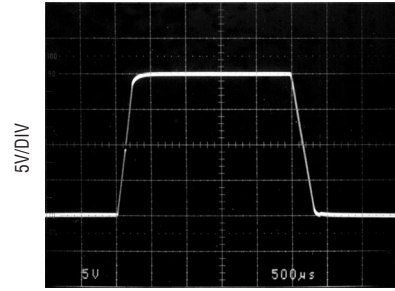

$V_S = \pm 15V$
 $R_L = 20k$
 $C_L = 50pF$
 500µs/DIV 1789-10 G45

Small-Signal Transient Response
G = 10

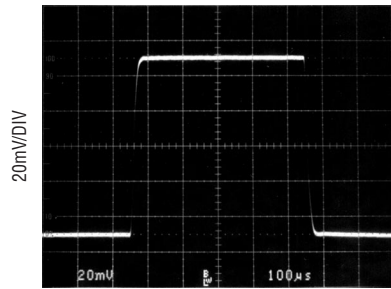

$V_S = 5V, 0V$
 $V_{REF} = 2.5V$
 $R_L = 20k$
 $C_L = 50pF$
 100µs/DIV 1789-10 G46

Small-Signal Transient Response
G = 100

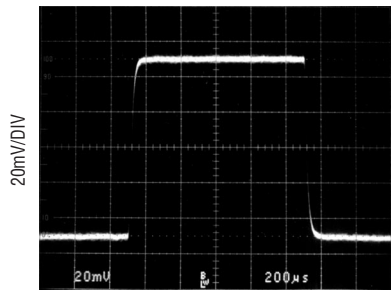

$V_S = 5V, 0V$
 $V_{REF} = 2.5V$
 $R_L = 20k$
 $C_L = 50pF$
 200µs/DIV 1789-10 G47

Small-Signal Transient Response
G = 1000

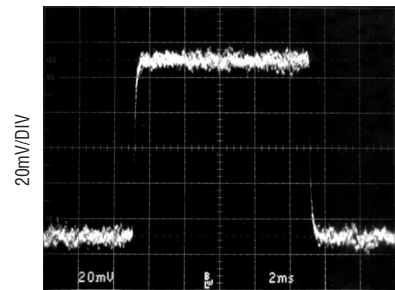

$V_S = 5V, 0V$
 $V_{REF} = 2.5V$
 $R_L = 20k$
 $C_L = 50pF$
 2ms/DIV 1789-10 G48

TYPICAL PERFORMANCE CHARACTERISTICS (LT1789-1)

Valid Output Voltage vs Input Common Mode Voltage
 $V_S = \pm 15V$

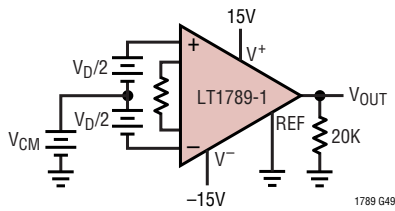
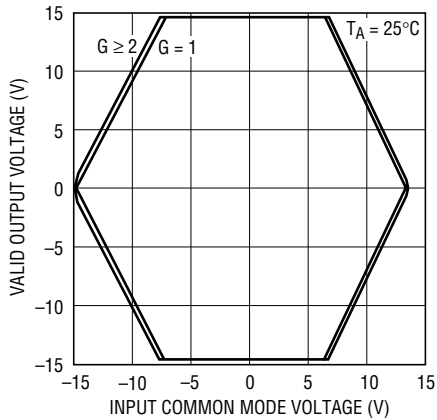

Valid Output Voltage vs Input Common Mode Voltage
 $V_S = \pm 2.5V$

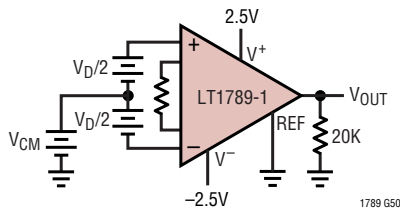
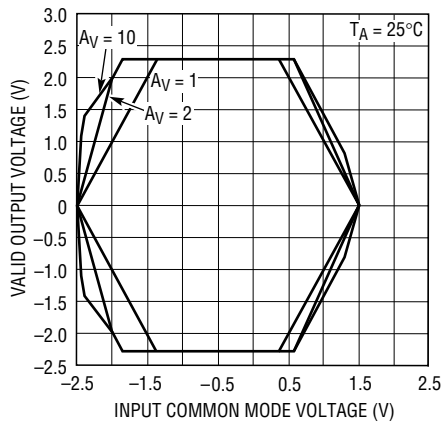

Valid Output Voltage vs Input Common Mode Voltage
 $V_S = \pm 1.5V$

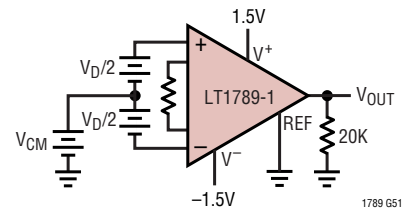
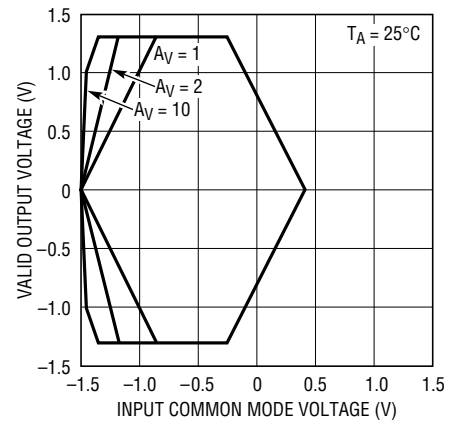

Valid Output Voltage vs Input Common Mode Voltage
 $V_S = 5V$

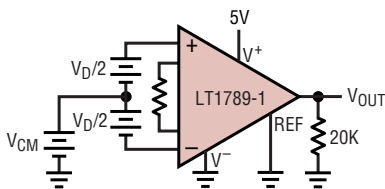
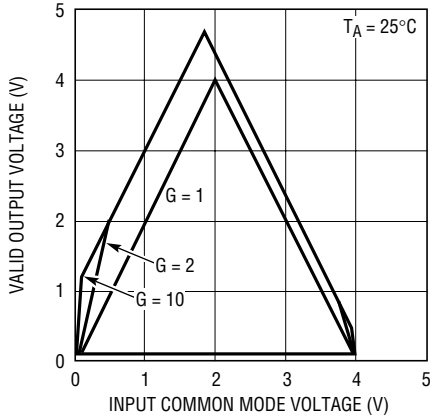

Valid Output Voltage vs Input Common Mode Voltage
 $V_S = 3V$

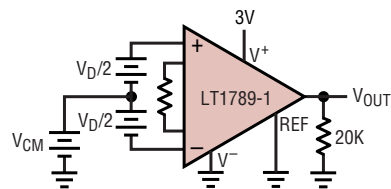
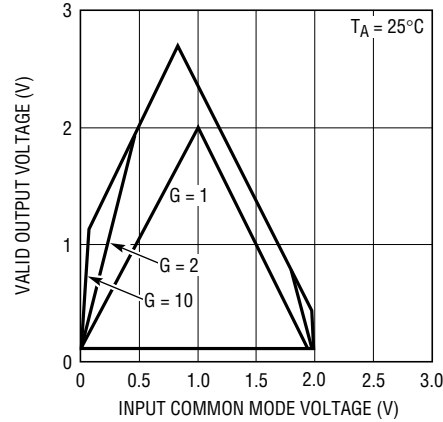

TYPICAL PERFORMANCE CHARACTERISTICS (LT1789-10)

Valid Output Voltage vs Input Common Mode Voltage
 $V_S = \pm 15V$

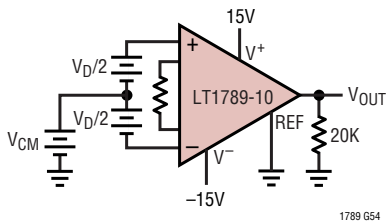
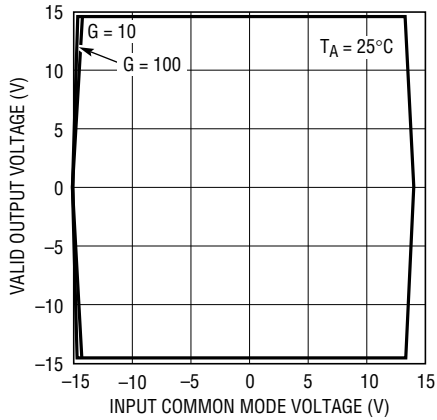

Valid Output Voltage vs Input Common Mode Voltage
 $V_S = \pm 2.5V$

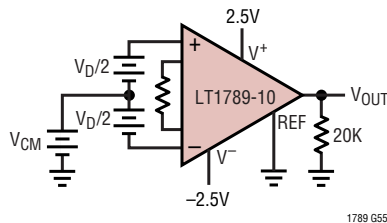
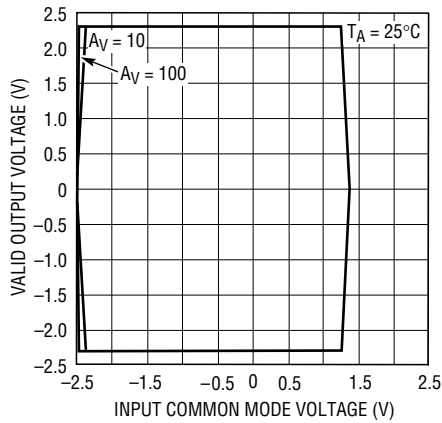

Valid Output Voltage vs Input Common Mode Voltage
 $V_S = \pm 1.5V$

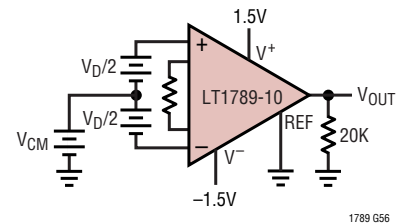
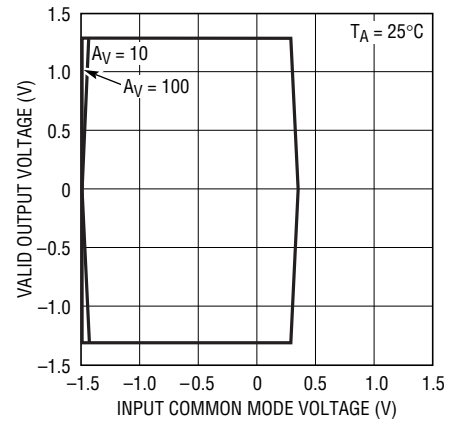

Valid Output Voltage vs Input Common Mode Voltage
 $V_S = 5V$

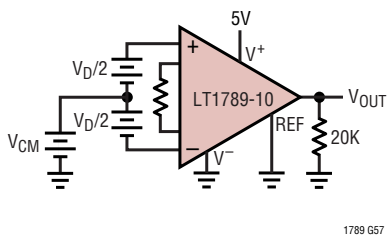
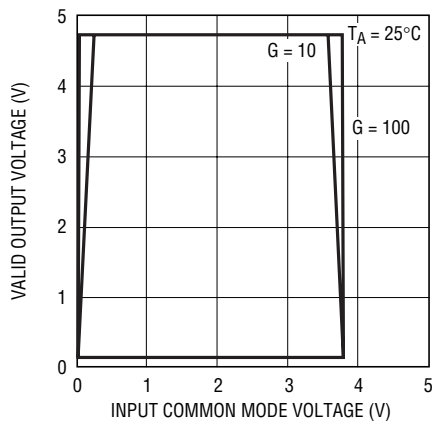

Valid Output Voltage vs Input Common Mode Voltage
 $V_S = 3V$

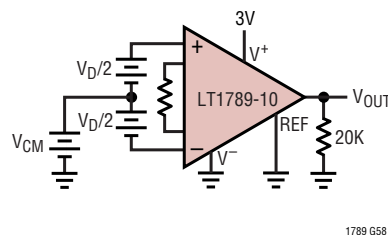
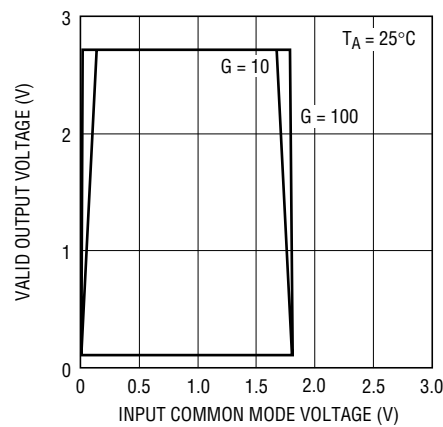

BLOCK DIAGRAM

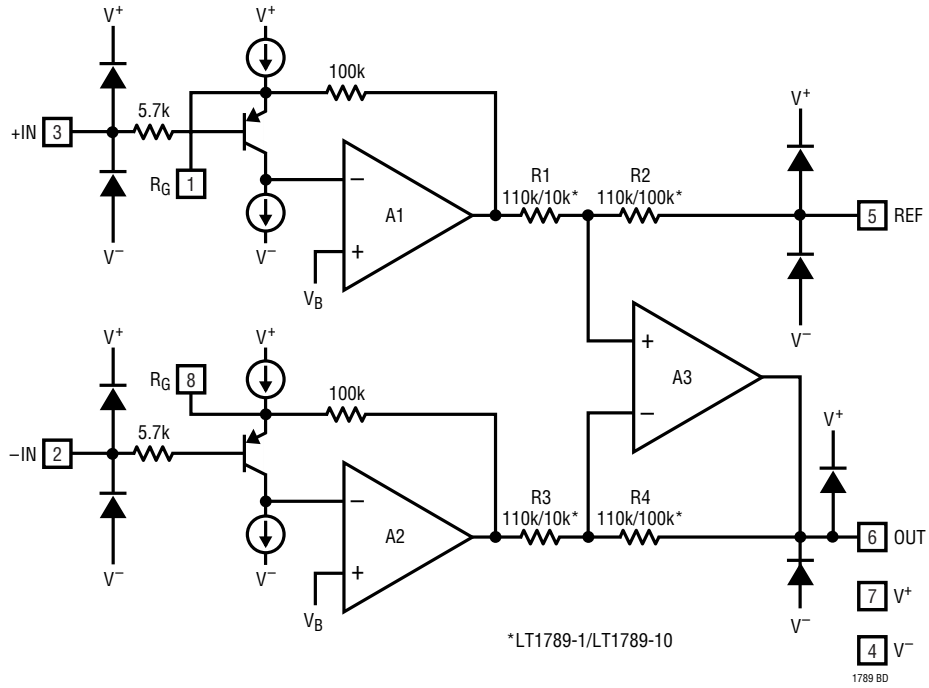

Figure 1. Block Diagram

APPLICATIONS INFORMATION

Setting the Gain

The gain of the LT1789-1 and LT1789-10 is set by the value of resistor R_G , applied across pins 1 and 8. For the LT1789-1, the gain G will be:

$$G = 1 + 200k/R_G$$

and R_G can be calculated from the desired gain by

$$R_G = 200k/(G - 1)$$

For the LT1789-10, the gain G will be

$$G = 10 \cdot (1 + 200k/R_G)$$

and R_G can be calculated from the desired gain by

$$R_G = 200k/(0.1 \cdot G - 1)$$

For the lowest achievable gain, R_G may be set to infinity by leaving Pins 1 and 8 open.

Input and Output Offset Voltage

The offset voltage of the LT1789-1/LT1789-10 has two components: the output offset and the input offset. The total offset voltage referred to the input (RTI) is found by dividing the output offset by the programmed gain (G) and adding it to the input offset. At high gains the input offset

voltage dominates, whereas at low gains the output offset voltage dominates. The total offset voltage is:

$$\begin{aligned} \text{Total input offset voltage (RTI)} \\ = \text{input offset} + (\text{output offset}/G) \end{aligned}$$

$$\begin{aligned} \text{Total output offset voltage (RTO)} \\ = (\text{input offset} \cdot G) + \text{output offset} \end{aligned}$$

Reference Terminal

The output voltage of the LT1789-1/LT1789-10 (Pin 6) is referenced to the voltage on the reference terminal (Pin 5). Resistance in series with the REF pin must be minimized for best common mode rejection. For example, a 22Ω resistance from the REF pin to ground will not only increase the gain error by 0.02% but will lower the CMRR to 80dB.

Output Offset Trimming

The LT1789-1/LT1789-10 is laser trimmed for low offset voltage so that no external offset trimming is required for most applications. In the event that the offset needs to be adjusted, the circuit in Figure 2 is an example of an optional offset adjust circuit. The op amp buffer provides a low impedance to the REF pin where resistance must be kept to a minimum for best CMRR and lowest gain error.

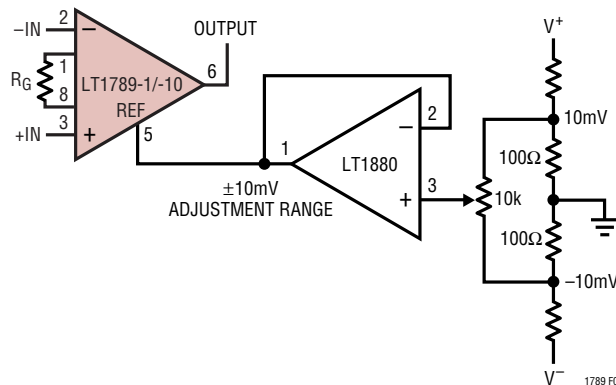

Figure 2. Optional Trimming of Output Offset Voltage

APPLICATIONS INFORMATION

Input Bias Current Return Path

The low input bias current of the LT1789-1/LT1789-10 (19nA) and the high input impedance (1.6GΩ) allow the use of high impedance sources without introducing significant offset voltage errors, even when the full common mode range is required. However, a path must be provided for the input bias currents of both inputs when a purely differential signal is being amplified. Without this path the inputs will float high and exceed the input common mode range of the LT1789-1/LT1789-10, resulting in a saturated input stage. Figure 3 shows three examples of an input bias current path. The first example is of a purely differential signal source with a 10kΩ input current path to ground. Since the impedance of the signal source is low, only one resistor is needed. Two matching resistors are needed for higher impedance signal sources as shown in the second example. Balancing the input impedance improves both common mode rejection and DC offset. The need for input resistors is eliminated if a center tap is present as shown in the third example.

Output Voltage vs Input Common Mode Voltage

All instrumentation amplifiers have limiting factors that can cause an output to be invalid (the output is not equal to the input differential voltage multiplied by the gain) even though the output appears to be operating in a linear region. Limiting factors such as input voltage range and output swing can be easily measured, however, there are also internal nodes that can limit. These internal nodes cannot be measured externally and can lead to erroneous output readings.

To ensure a valid output for a given input common mode voltage and input differential voltage, the following four limiting factors must be taken into consideration (refer to the block diagram):

- 1) The input voltage ranges of the input amplifiers A1 and A2.
- 2) The output swings of the input amplifiers A1 and A2 (internal nodes).

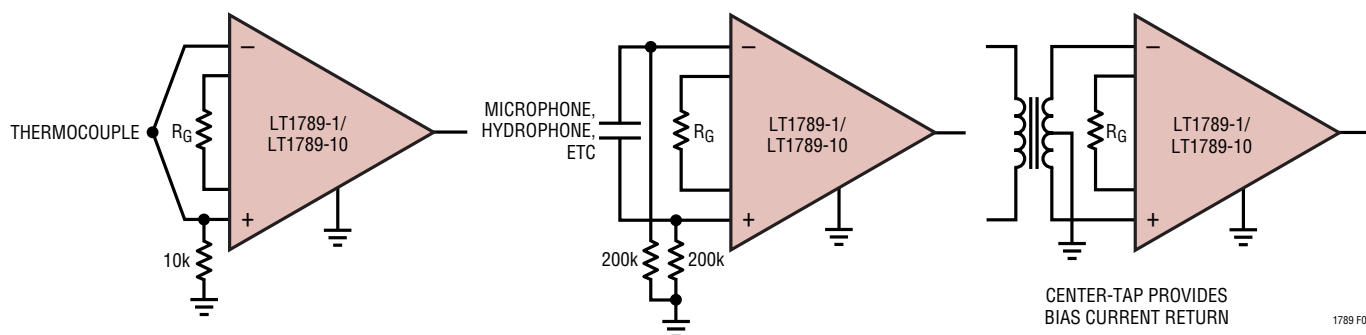

Figure 3. Providing an Input Common Mode Current Path

APPLICATIONS INFORMATION

- 3) The input voltage range of the output amplifier A3 (internal node).
- 4) The output swing of the output amplifier A3.

These limits can be determined using the relationships below.

1)The input voltage range limits can be found in the electrical tables.

2)The output voltages of the input amplifiers A1 and A2 can be found by the following formulas:

$$V_{OUT A1} = (V_D/2)(G)(R1/R2) + V_{CM} + 0.6V$$

$$V_{OUT A2} = (-V_D/2)(G)(R1/R2) + V_{CM} + 0.6V$$

Where V_D is the input differential voltage and V_{CM} is the input common mode voltage.

The typical output swing limits for A1 and A2 can be found in the Output Swing vs Load Current typical performance curve, using $R1 + R2$ as the load resistance.

This limitation usually becomes dominant when gain is taken in the input stage and the common mode input voltage is close to either supply rail.

The LT1789-10 is less susceptible to this limiting factor because the gain is taken in the output stage.

3)The voltage on the inputs to the output amplifier A3 can be determined by the following formula:

$$V_{IN A3} = (V_{OUT A1} - V_{REF})(R2/(R1 + R2))$$

The input voltage range of A3 has the same input limits as the LT1789-1. This limiting factor is more prevalent with

single supplies, where both the reference voltage and input common mode voltage are near V^+ . This is also more of a concern with the LT1789-10 because the ratio of $R1:R2$ is 1:10 instead of 1:1.

4)The output voltage swing limits are also found in the electrical tables.

The Output Voltage vs Input Common Mode Voltage typical performance curves show the regions of operation for the three supply voltages specified.

Single Supply Operation

There are usually two types of input signals that need to be processed; differential signals, like the output of a bridge or single ended signals, such as the output from a thermistor. Both signals require special consideration when operating with a single supply.

When processing differential signals, REF (Pin 5) must be brought above the negative supply (Pin 4) to allow the output to process both the positive and negative going input signal. The maximum output operating range is obtained by setting the voltage on the REF pin to half supply. This must be done with a low impedance source to minimize CMRR and gain errors.

For single ended input signals, the REF pin can be at the same potential as the negative supply provided the output of the instrumentation amplifier remains inside the specified operating range. This maximizes the output range, however the smallest input signal that can be processed is limited by the output swing to the negative supply.

TYPICAL APPLICATIONS

Single Supply Positive Integrator

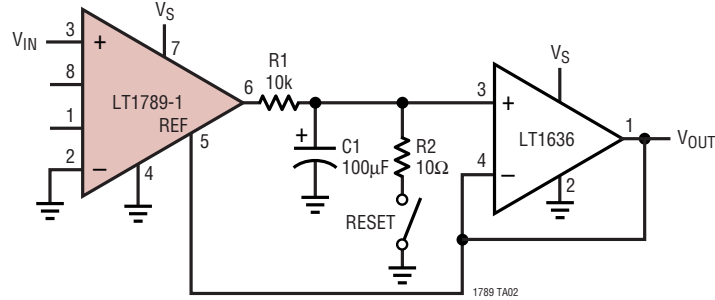

$V_S = 2.7V \text{ TO } 32V$
 TIME CONSTANT = $(R1)(C1) = 1 \text{ SECOND AS SHOWN}$

Avalanche Photo Diode Module Bias Current Monitor

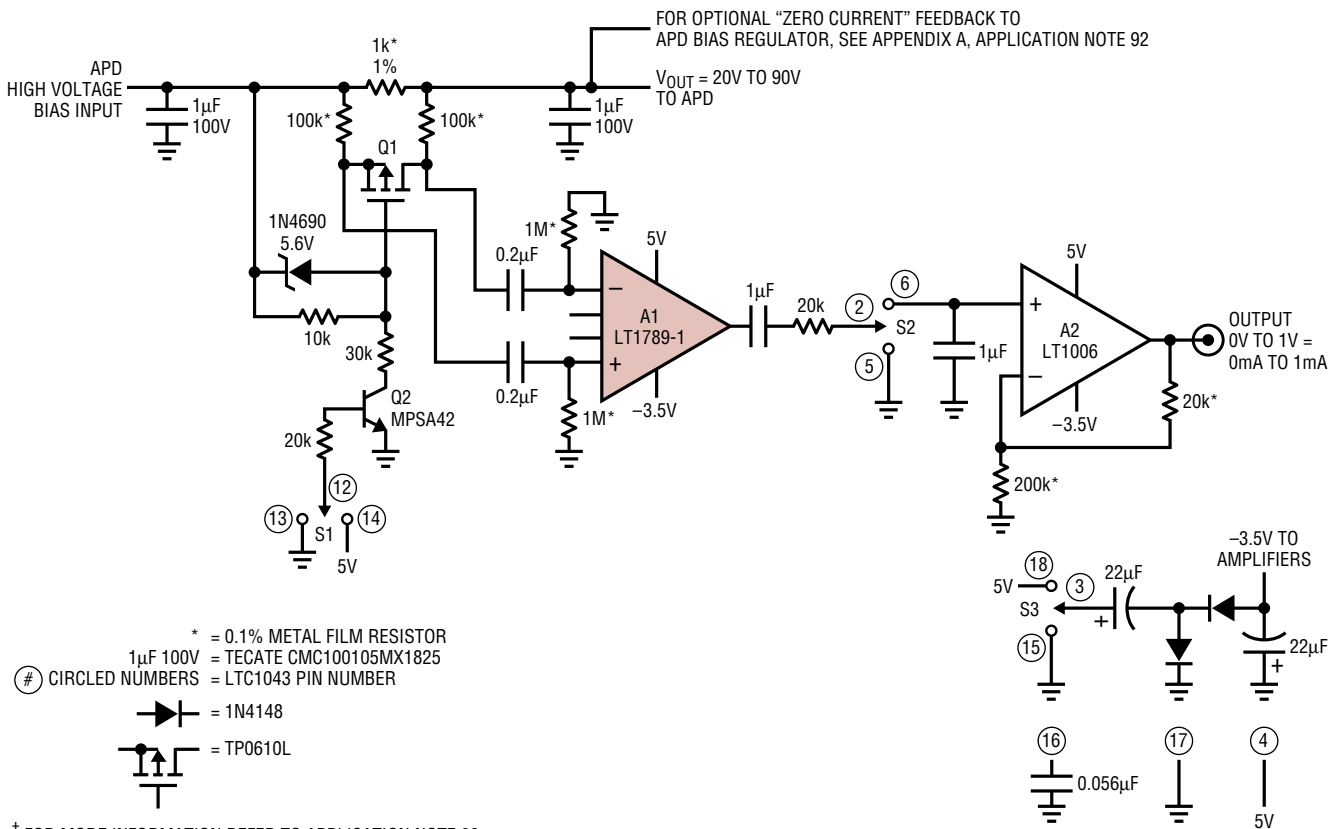

AN92 F04

PACKAGE DESCRIPTION

S8 Package
8-Lead Plastic Small Outline (Narrow .150 Inch)
 (Reference LTC DWG # 05-08-1610)

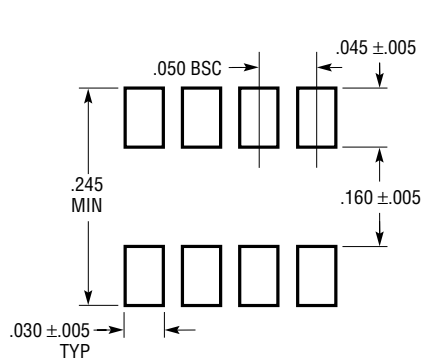

RECOMMENDED SOLDER PAD LAYOUT

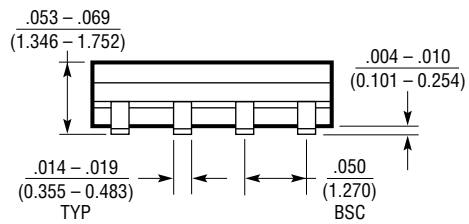
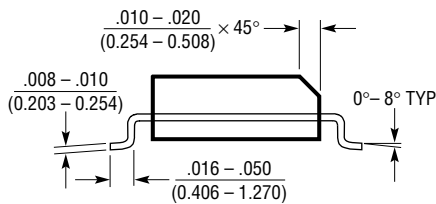
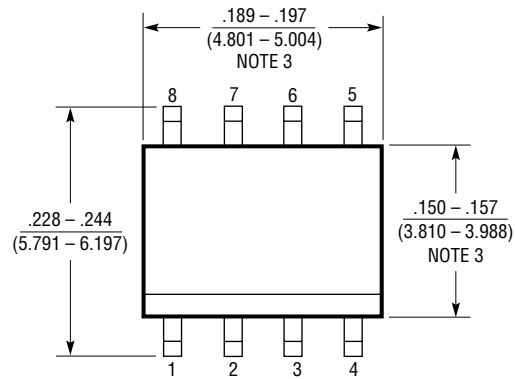

- NOTE:
 1. DIMENSIONS IN $\frac{\text{INCHES}}{\text{MILLIMETERS}}$
 2. DRAWING NOT TO SCALE
 3. THESE DIMENSIONS DO NOT INCLUDE MOLD FLASH OR PROTRUSIONS.
 MOLD FLASH OR PROTRUSIONS SHALL NOT EXCEED .006" (0.15mm)

S08 0303

TYPICAL APPLICATIONS

Voltage Controlled Current Source

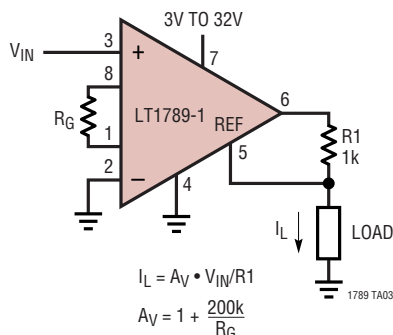

10°C to 40°C Thermometer

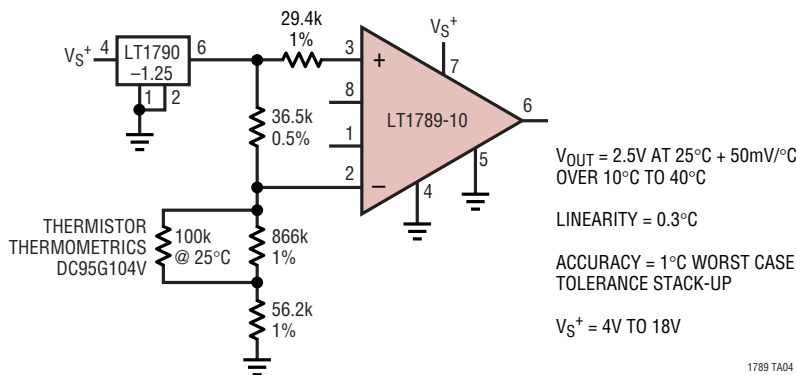

RELATED PARTS

PART NUMBER	DESCRIPTION	COMMENTS
LTC1100	Precision Chopper-Stabilized Instrumentation Amplifier	Best DC Accuracy
LT1101	Precision, Micropower, Single Supply Instrumentation Amplifier	Fixed Gain of 10 or 100, $I_S < 105\mu\text{A}$
LT1102	High Speed, JFET Instrumentation Amplifier	Fixed Gain of 10 or 100, 30V/ μs Slew Rate
LT1167	Single Resistor Gain Programmable, Precision Instrumentation Amplifier	Gain Error: 0.08% Max, Gain Nonlinearity: 10ppm Max, 60 μV Max Input Offset Voltage, 90dB Min CMRR
LT1168	Low Power, Single Resistor Programmable Instrumentation Amplifier	$I_{SUPPLY} = 530\mu\text{A}$ Max
LTC [®] 1418	14-Bit, Low Power, 200ksps ADC with Serial and Parallel I/O	Single Supply 5V or $\pm 5V$ Operation, $\pm 1.5\text{LSB}$ INL and $\pm 1\text{LSB}$ DNL Max
LT1460	Precision Series Reference	Micropower; 2.5V, 5V, 10V Versions; High Precision
LT1468	16-Bit Accurate Op Amp, Low Noise Fast Settling	16-Bit Accuracy at Low and High Frequencies, 90MHz GBW, 22V/ μs , 900ns Settling
LTC1562	Active RC Filter	Lowpass, Bandpass, Highpass Responses; Low Noise, Low Distortion, Four 2nd Order Filter Sections
LTC1605	16-Bit, 100ksps, Sampling ADC	Single 5V Supply, Bipolar Input Range: $\pm 10V$, Power Dissipation: 55mW Typ

1789f