



Wideband, > 40dB Gain Adjust Range, Linear in V/V VARIABLE GAIN AMPLIFIER

FEATURES

- 150MHz SMALL-SIGNAL BANDWIDTH (G = +10V/V)
- 137MHz, 5V_{pp} BANDWIDTH (G = +10V/V)
- 0.1dB GAIN FLATNESS to 28MHz
- 1700V/μs SLEW RATE
- > 40dB GAIN ADJUST RANGE
- HIGH GAIN ACCURACY: 20dB ±0.3dB
- HIGH OUTPUT CURRENT: ±160mA

APPLICATIONS

- DIFFERENTIAL LINE RECEIVERS
- DIFFERENTIAL EQUALIZERS
- PULSE AMPLITUDE COMPENSATION
- VARIABLE ATTENUATORS
- VOLTAGE-TUNABLE ACTIVE FILTERS
- DROP-IN UPGRADE TO LMH6503

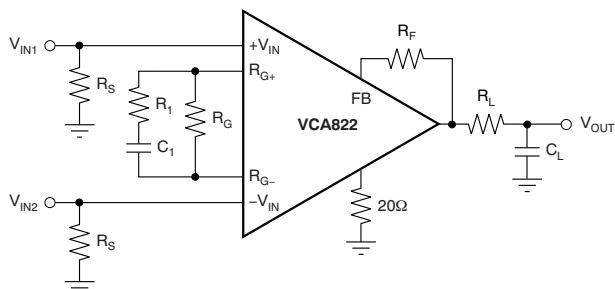

Figure 1. Differential Equalizer

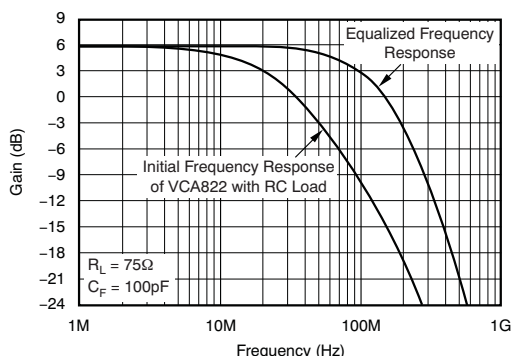

Figure 2. Differential Equalization of an RC Load

DESCRIPTION

The VCA822 is a dc-coupled, wideband, linear in V/V, continuously variable, voltage-controlled gain amplifier. It provides a differential input to single-ended conversion with a high-impedance gain control input used to vary the gain down 40dB from the nominal maximum gain set by the gain resistor (R_G) and feedback resistor (R_F).

The VCA822 internal architecture consists of two input buffers and an output current feedback amplifier stage integrated with a multiplier core to provide a complete variable gain amplifier (VGA) system that does not require external buffering. The maximum gain is set externally with two resistors, providing flexibility in designs. The maximum gain is intended to be set between +2V/V and +100V/V. Operating from ±5V supplies, the gain control voltage for the VCA822 adjusts the gain linearly in V/V as the control voltage varies from +1V to -1V. For example, set for a maximum gain of +10V/V, the VCA822 provides 10V/V, at +1V input, to 0.1V/V at -1V input of gain control range. The VCA822 offers excellent gain linearity. For a 20dB maximum gain, and a gain-control input voltage varying between 0V and 1V, the gain does not deviate by more than ±0.3dB (maximum at +25°C).

Table 1. VCA822 RELATED PRODUCTS

SINGLES	DUALS	GAIN ADJUST RANGE (dB)	INPUT NOISE (nV/√Hz)	SIGNAL BANDWIDTH (MHz)
VCA810	—	80	2.4	35
—	VCA2612	45	1.25	80
—	VCA2613	45	1	80
—	VCA2615	52	0.8	50
—	VCA2617	48	4.1	50
VCA820	—	40	8.2	150
VCA821	—	40	7.0	420
VCA822	—	40	8.2	150
VCA824	—	40	7.0	420



Please be aware that an important notice concerning availability, standard warranty, and use in critical applications of Texas Instruments semiconductor products and disclaimers thereto appears at the end of this data sheet.

X2Y is a trademark of X2Y Corporation.

All other trademarks are the property of their respective owners.



This integrated circuit can be damaged by ESD. Texas Instruments recommends that all integrated circuits be handled with appropriate precautions. Failure to observe proper handling and installation procedures can cause damage.

ESD damage can range from subtle performance degradation to complete device failure. Precision integrated circuits may be more susceptible to damage because very small parametric changes could cause the device not to meet its published specifications.

ORDERING INFORMATION⁽¹⁾

PRODUCT	PACKAGE-LEAD	PACKAGE DESIGNATOR	SPECIFIED TEMPERATURE RANGE	PACKAGE MARKING	ORDERING NUMBER	TRANSPORT MEDIA, QUANTITY
VCA822	SO-14	D	–40°C to +85°C	VCA822ID	VCA822ID	Rail, 50
					VCA822IDR	Tape and Reel, 2500
VCA822	MSOP-10	DGS	–40°C to +85°C	BOS	VCA822IDGST	Tape and Reel, 250
					VCA822IDGSR	Tape and Reel, 2500

(1) For the most current package and ordering information see the Package Option Addendum at the end of this document, or see the TI web site at www.ti.com.

ABSOLUTE MAXIMUM RATINGS⁽¹⁾

Over operating free-air temperature range, unless otherwise noted.

		VCA822	UNIT
Power supply		±6.5	V
Internal power dissipation		See Thermal Characteristics	
Input voltage range		±V _S	V
Storage temperature range		–65 to +125	°C
Lead temperature (soldering, 10s)		+260	°C
Junction temperature (T _J)		+150	°C
Junction temperature (T _J), maximum continuous operation		+140	°C
ESD ratings	Human body model (HBM)	2000	V
	Charged device model (CDM)	500	V
	Machine model (MM)	200	V

(1) Stresses beyond those listed under Absolute Maximum Ratings may cause permanent damage to the device. These are stress ratings only, and functional operation of the device at these or any other conditions beyond those indicated is not implied. Exposure to absolute-maximum rated conditions for extended periods may affect device reliability.

PIN CONFIGURATIONS

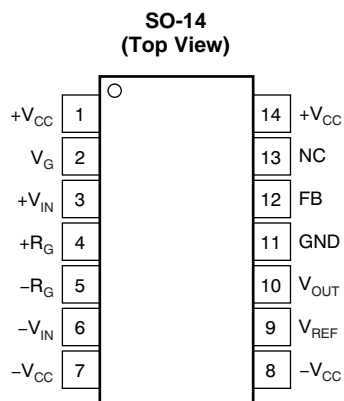

NC = No Connection

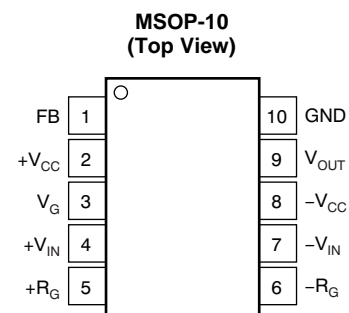

ELECTRICAL CHARACTERISTICS: $V_S = \pm 5V$

 At $A_{VMAX} = +10V/V$, $R_F = 1k\Omega$, $R_G = 200\Omega$, and $R_L = 100\Omega$, unless otherwise noted.

PARAMETER	CONDITIONS	VCA822				UNITS	MIN/ MAX	TEST LEVEL ⁽¹⁾
		TYP	MIN/MAX OVER TEMPERATURE					
		+25°C	+25°C ⁽²⁾	0°C to 70°C ⁽³⁾	–40°C to +85°C ⁽³⁾			
AC PERFORMANCE								
Small-signal bandwidth (SO-14 Package)	$A_{VMAX} = +2V/V$, $V_O = 1V_{PP}$, $V_G = 1V$	168				MHz	typ	C
	$A_{VMAX} = +10V/V$, $V_O = 1V_{PP}$, $V_G = 1V$	150				MHz	typ	C
	$A_{VMAX} = +100V/V$, $V_O = 1V_{PP}$, $V_G = 1V$	118				MHz	typ	C
Large-signal bandwidth	$A_{VMAX} = +10V/V$, $V_O = 5V_{PP}$, $V_G = 1V$	137				MHz	typ	C
Gain control bandwidth	$V_G = 0V_{DC} + 10mV_{PP}$	200	170	170	165	MHz	min	B
Bandwidth for 0.1dB flatness	$A_{VMAX} = +10V/V$, $V_O = 1V_{PP}$, $V_G = 1V$	28				MHz	typ	C
Slew rate	$A_{VMAX} = +10V/V$, $V_O = 5V$ Step, $V_G = 1V$	1700	1500	1500	1450	V/ μ s	min	B
Rise-and-fall time	$A_{VMAX} = +10V/V$, $V_O = 5V$ Step, $V_G = 1V$	2.5	3.1	3.2	3.2	ns	max	B
Settling time to 0.01%	$A_{VMAX} = +10V/V$, $V_O = 5V$ Step, $V_G = 1V$	11				ns	typ	C
Harmonic distortion								
2nd-harmonic	$V_O = 2V_{PP}$, $f = 20MHz$, $V_G = 1V$	–62	–60	–60	–60	dBc	min	B
3rd-harmonic	$V_O = 2V_{PP}$, $f = 20MHz$, $V_G = 1V$	–68	–66	–66	–66	dBc	min	B
Input voltage noise	$f > 100kHz$, $V_G = 1V$	8.2				nV/ \sqrt{Hz}	typ	C
Input current noise	$f > 100kHz$, $V_G = 1V$	2.6				pA/ \sqrt{Hz}	typ	C
GAIN CONTROL								
Absolute gain error	$A_{VMAX} = +10V/V$, $V_G = 1V$	± 0.1	± 0.4	± 0.5	± 0.6	dB	max	A
Gain deviation	$A_{VMAX} = +10V/V$, $0 < V_G < 1V$	± 0.05	± 0.3	± 0.34	± 0.37	dB	max	A
Gain deviation	$A_{VMAX} = +10V/V$, $-0.8 < V_G < 1V$	± 1.06	± 1.9	± 2.1	± 2.2	dB	max	A
Gain at $V_G = -0.9V$	Relative to maximum gain	–26	–24	–24	–23	dB	max	A
Gain control bias current	$V_G = 0V$	22	30	35	37	μ A	max	A
Average gain control bias current drift	$V_G = 0V$			± 100	± 100	nA/ $^{\circ}$ C	max	B
Gain control input impedance		70 1				k Ω pF	typ	C
DC PERFORMANCE								
Input offset voltage	$A_{VMAX} = +10V/V$, $V_{CM} = 0V$, $V_G = 0V$	± 4	± 17	± 17.8	± 19	mV	max	A
Average input offset voltage drift	$A_{VMAX} = +10V/V$, $V_{CM} = 0V$, $V_G = 0V$			± 30	± 30	μ V/ $^{\circ}$ C	max	B
Input bias current	$A_{VMAX} = +10V/V$, $V_{CM} = 0V$, $V_G = 0V$	19	25	29	31	μ A	max	A
Average input bias current drift	$A_{VMAX} = +10V/V$, $V_{CM} = 0V$, $V_G = 0V$			± 90	± 90	nA/ $^{\circ}$ C	max	B
Input offset current	$A_{VMAX} = +10V/V$, $V_{CM} = 0V$, $V_G = 0V$	± 0.5	± 2.5	± 3.2	± 3.5	μ A	max	A
Average input offset current drift	$A_{VMAX} = +10V/V$, $V_{CM} = 0V$, $V_G = 0V$			± 16	± 16	nA/ $^{\circ}$ C	max	B
Maximum current through gain resistance ($I_{RG\ MAX}$)		± 2.6	± 2.55	± 2.55	± 2.5	mA	max	B
INPUT								
Most positive input voltage	$R_L = 100\Omega$	+1.6	+1.6	+1.6	+1.6	V	min	A
Most negative input voltage	$R_L = 100\Omega$	–2.1	–2.1	–2.1	–2.1	V	max	A
Common-mode rejection ratio	$V_{CM} = \pm 0.5V$	80	65	60	60	dB	min	A
Input impedance								
Differential		0.5 1				M Ω pF	typ	C
Common-mode		0.5 2				M Ω pF	typ	C

(1) Test levels: **(A)** 100% tested at +25°C. Over temperature limits set by characterization and simulation. **(B)** Limits set by characterization and simulation. **(C)** Typical value only for information.

(2) Junction temperature = ambient for +25°C tested specifications.

(3) Junction temperature = ambient at low temperature limit; junction temperature = ambient +23°C at high temperature limit for over temperature specifications.

ELECTRICAL CHARACTERISTICS: $V_S = \pm 5V$ (continued)At $A_{V_{MAX}} = +10V/V$, $R_F = 1k\Omega$, $R_G = 200\Omega$, and $R_L = 100\Omega$, unless otherwise noted.

PARAMETER	CONDITIONS	VCA822				UNITS	MIN/ MAX	TEST LEVEL ⁽¹⁾
		TYP	MIN/MAX OVER TEMPERATURE					
		+25°C	+25°C ⁽²⁾	0°C to 70°C ⁽³⁾	–40°C to +85°C ⁽³⁾			
OUTPUT								
Output voltage swing	$R_L = 1k\Omega$	±4.0	±3.8	±3.75	±3.7	V	min	A
	$R_L = 100\Omega$	±3.9	±3.7	±3.6	±3.5	V	min	A
Output current	$V_O = 0V$, $R_L = 5\Omega$	±160	±140	±130	±130	mA	min	A
Output impedance	$A_{V_{MAX}} = +10V/V$, $f > 100kHz$, $V_G = 1V$	0.01				Ω	typ	C
POWER SUPPLY								
Specified operating voltage		±5				V	typ	C
Minimum operating voltage		±3.5				V	typ	C
Maximum operating voltage			±6	±6	±6	V	max	A
Maximum quiescent current	$V_G = 0V$	36	37	37.5	38	mA	max	A
Minimum quiescent current	$V_G = 0V$	36	34.5	34	33.5	mA	max	A
Power-supply rejection ratio (–PSRR)	$V_G = +1V$	–68	–61	–59	–58	dB	min	A
THERMAL CHARACTERISTICS								
Specified operating range, D package		–40 to +85				°C	typ	C
Thermal resistance, θ_{JA}	Junction-to-ambient							
DGS MSOP-10		130				°C/W	typ	C
D SO-14		80				°C/W	typ	C

TYPICAL CHARACTERISTICS: $V_S = \pm 5V$, DC Parameters

At $T_A = +25^\circ C$, $R_L = 100\Omega$, $V_G = +1V$, and V_{IN} = single-ended input on $+V_{IN}$ with $-V_{IN}$ at ground, unless otherwise noted.

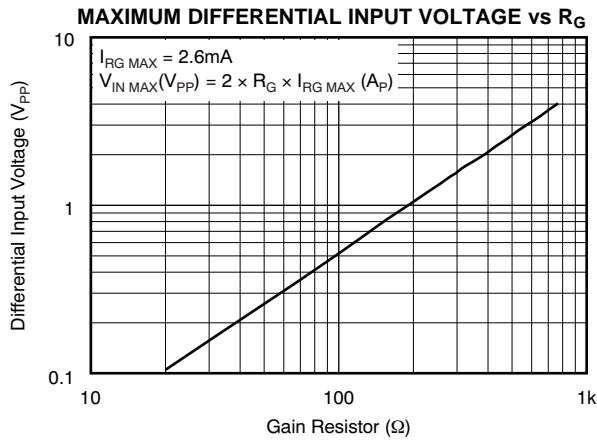

Figure 3.

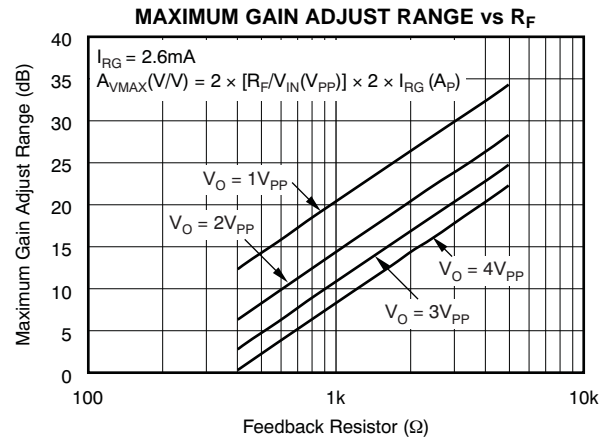

Figure 4.

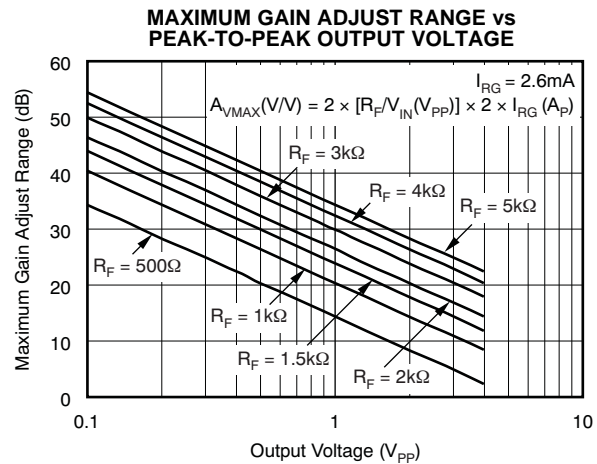

Figure 5.

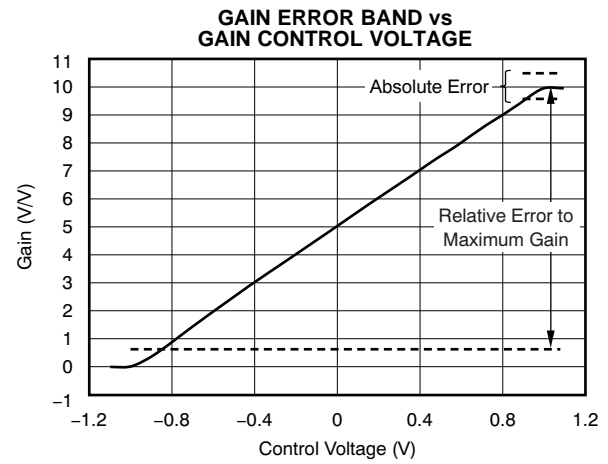

Figure 6.

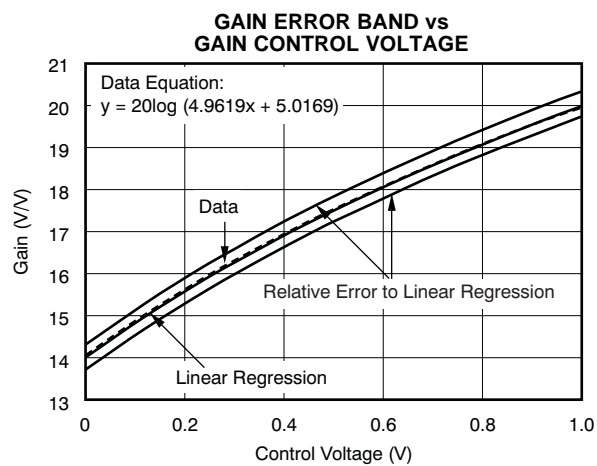

Figure 7.

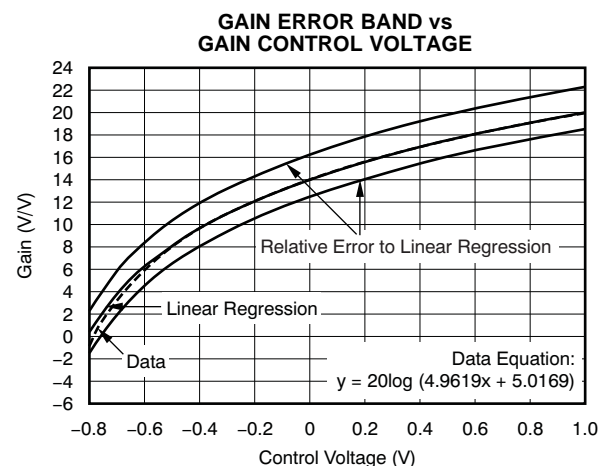

Figure 8.

TYPICAL CHARACTERISTICS: $V_S = \pm 5V$, DC and Power-Supply Parameters

At $T_A = +25^\circ C$, $R_L = 100\Omega$, $V_G = +1V$, and V_{IN} = single-ended input on $+V_{IN}$ with $-V_{IN}$ at ground, unless otherwise noted.

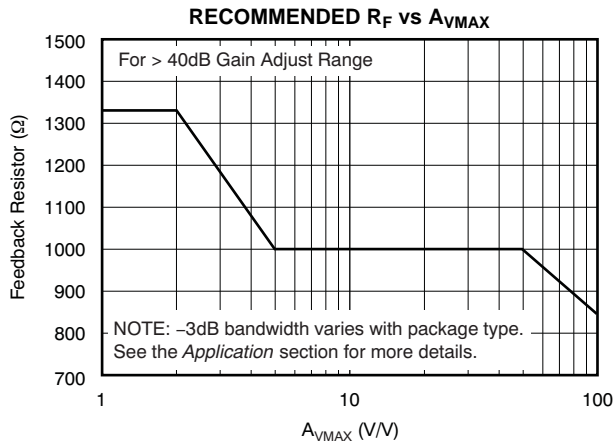

Figure 9.

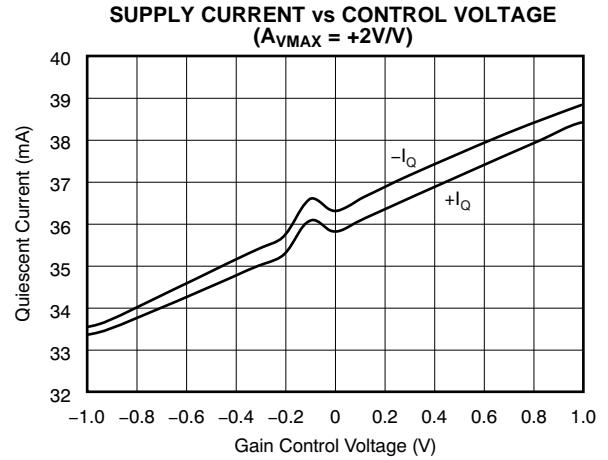

Figure 10.

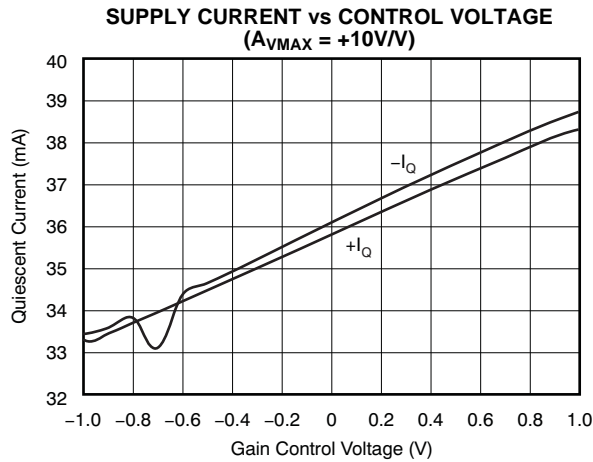

Figure 11.

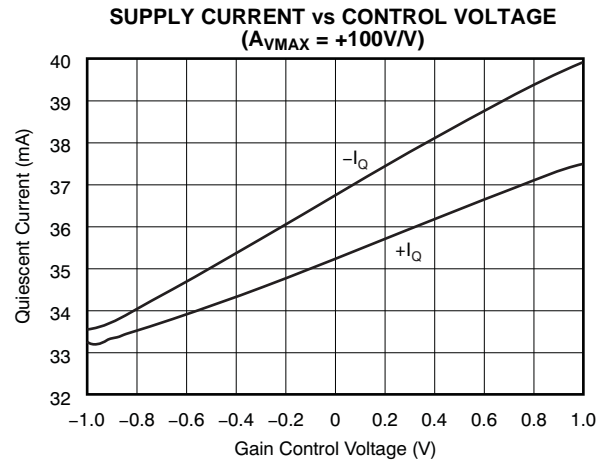

Figure 12.

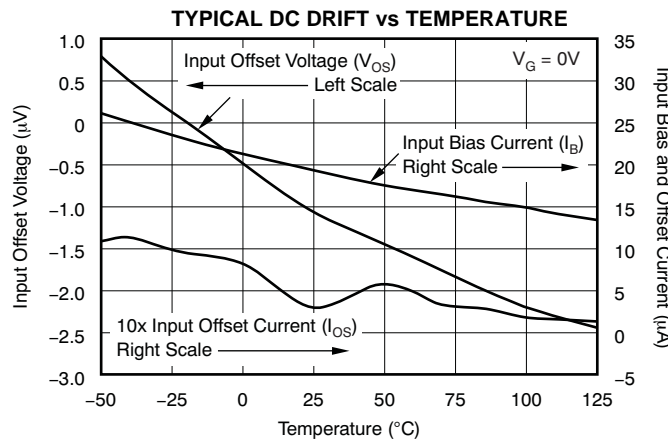

Figure 13.

TYPICAL CHARACTERISTICS: $V_S = \pm 5V$, $A_{VMAX} = +2V/V$

At $T_A = +25^\circ C$, $R_L = 100\Omega$, $R_F = 1.33k\Omega$, $R_G = 1.33k\Omega$, $V_G = +1V$, V_{IN} = single-ended input on $+V_{IN}$ with $-V_{IN}$ at ground, and SO-14 package, unless otherwise noted.

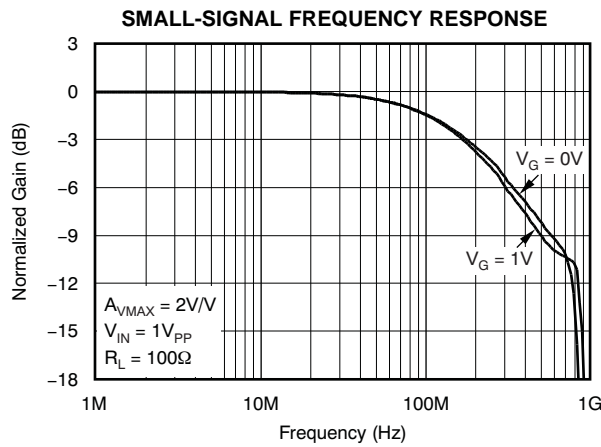

Figure 14.

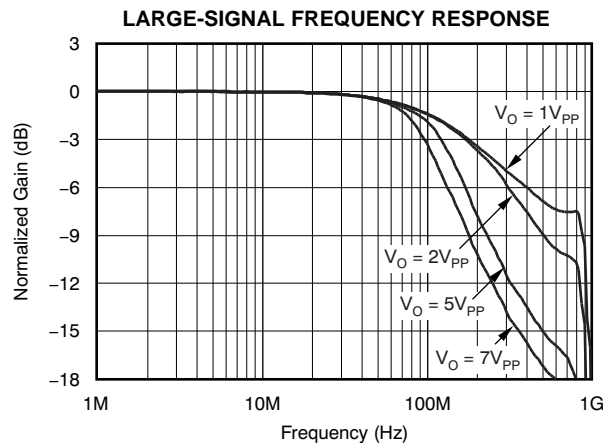

Figure 15.

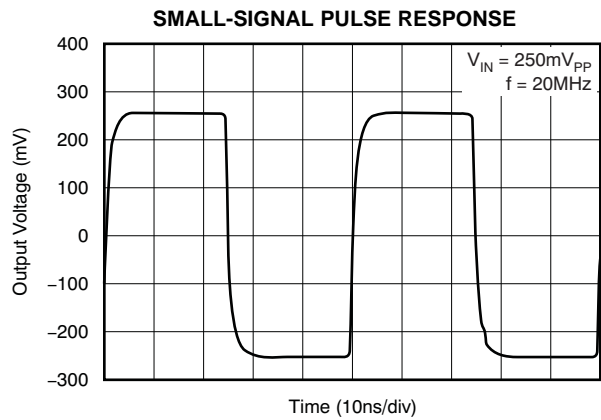

Figure 16.

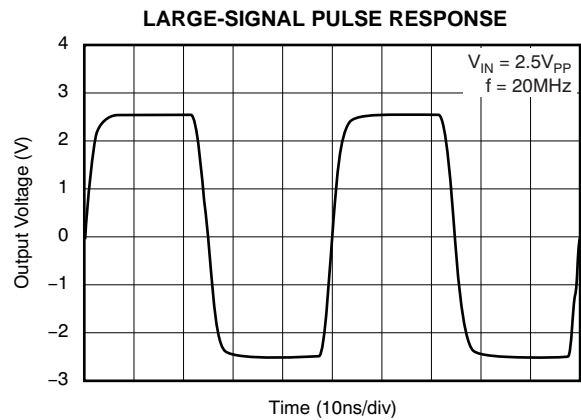

Figure 17.

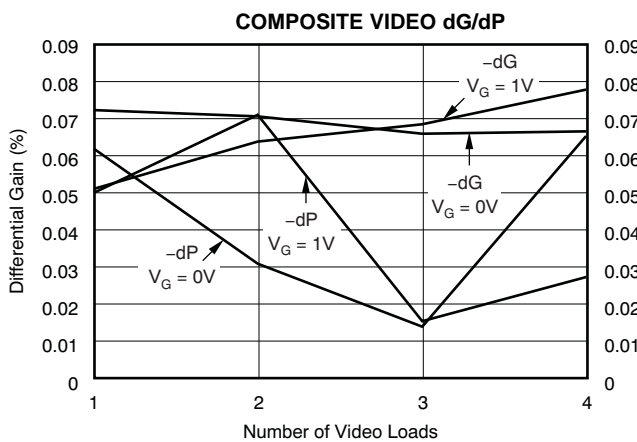

Figure 18.

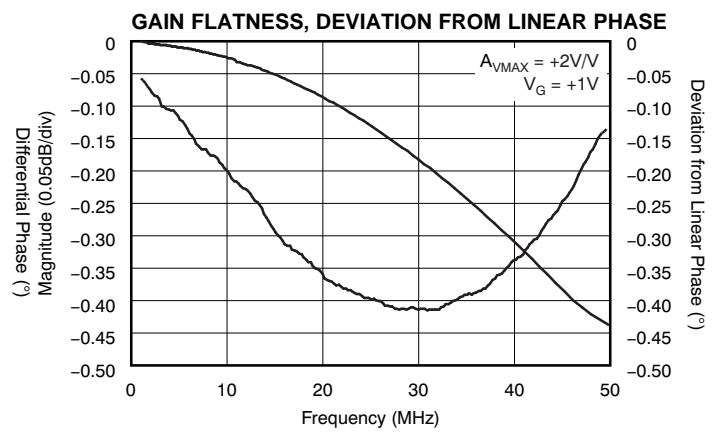

Figure 19.

TYPICAL CHARACTERISTICS: $V_S = \pm 5V$, $A_{VMAX} = +2V/V$ (continued)

At $T_A = +25^\circ C$, $R_L = 100\Omega$, $R_F = 1.33k\Omega$, $R_G = 1.33k\Omega$, $V_G = +1V$, V_{IN} = single-ended input on $+V_{IN}$ with $-V_{IN}$ at ground, and SO-14 package, unless otherwise noted.

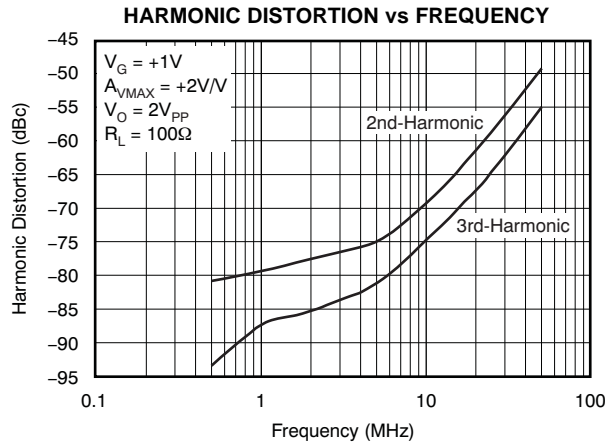

Figure 20.

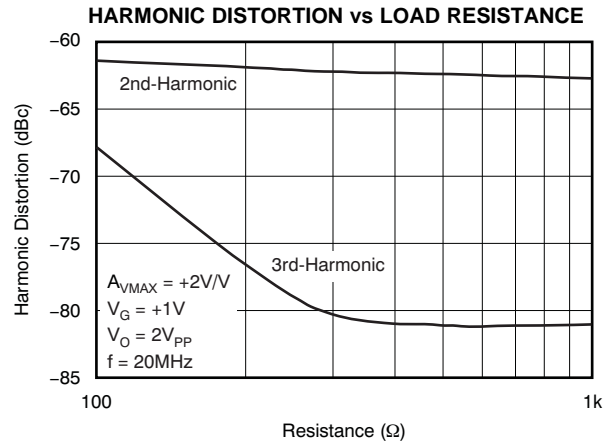

Figure 21.

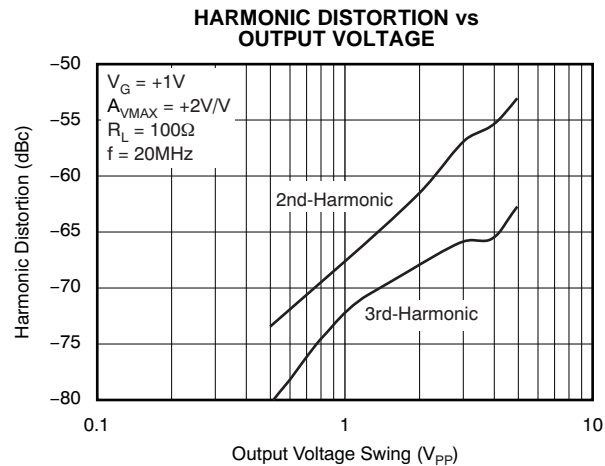

Figure 22.

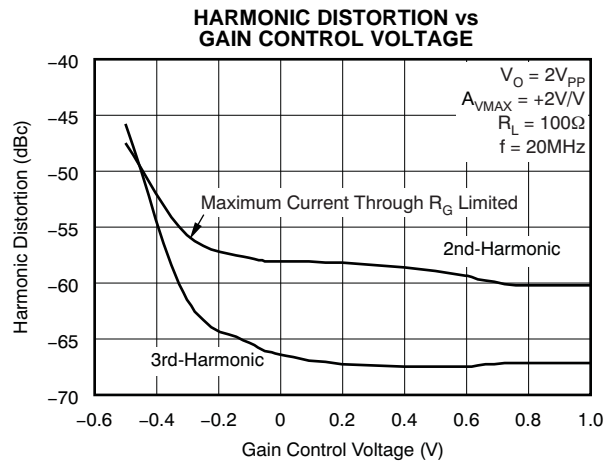

Figure 23.

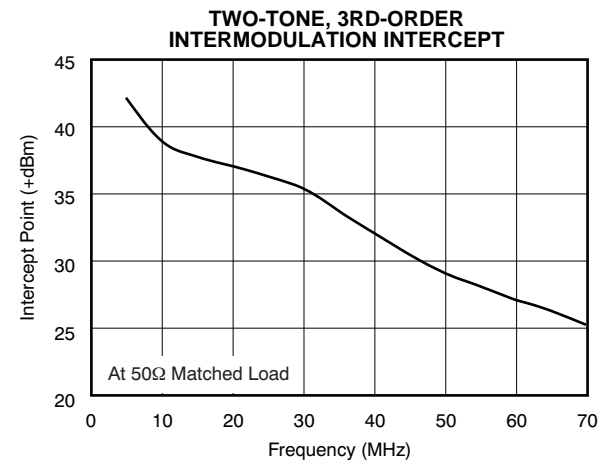

Figure 24.

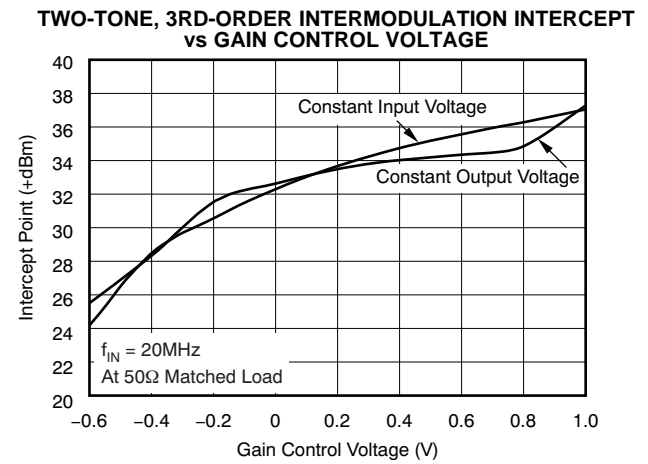

Figure 25.

TYPICAL CHARACTERISTICS: $V_S = \pm 5V$, $A_{V_{MAX}} = +2V/V$ (continued)

At $T_A = +25^\circ C$, $R_L = 100\Omega$, $R_F = 1.33k\Omega$, $R_G = 1.33k\Omega$, $V_G = +1V$, V_{IN} = single-ended input on $+V_{IN}$ with $-V_{IN}$ at ground, and SO-14 package, unless otherwise noted.

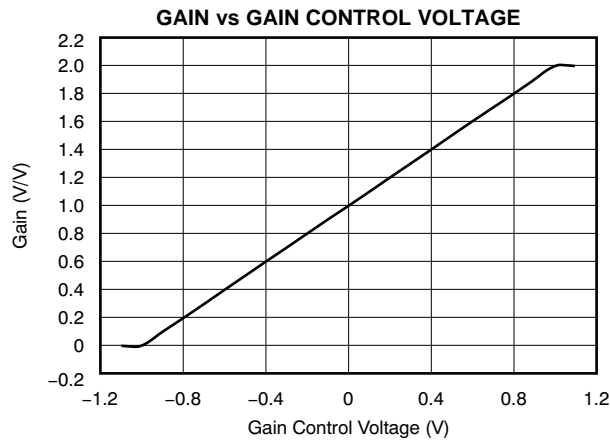

Figure 26.

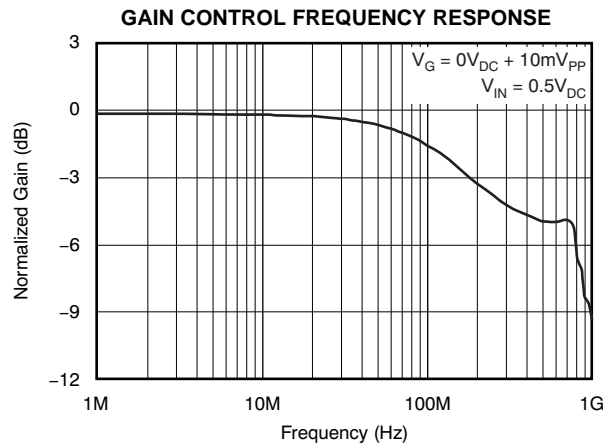

Figure 27.

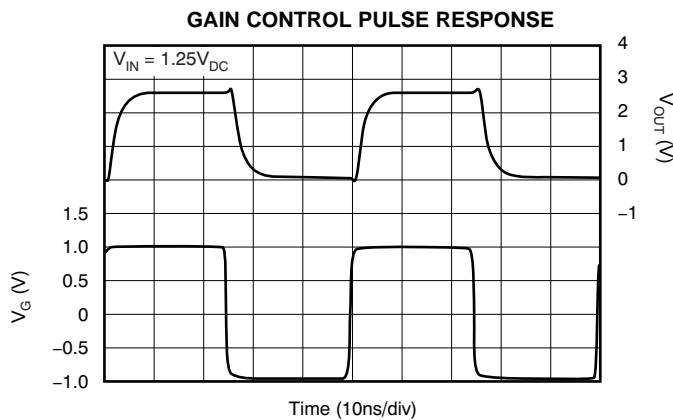

Figure 28.

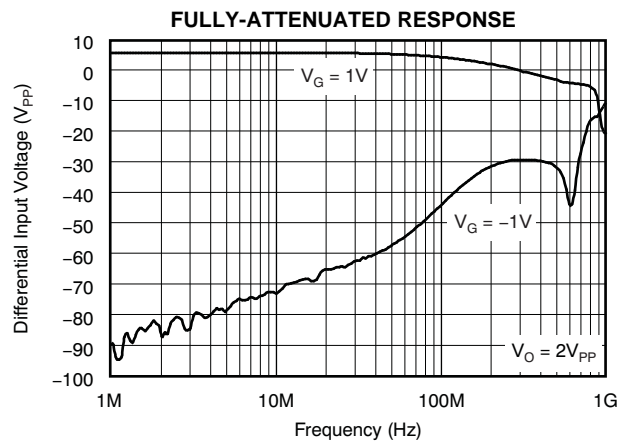

Figure 29.

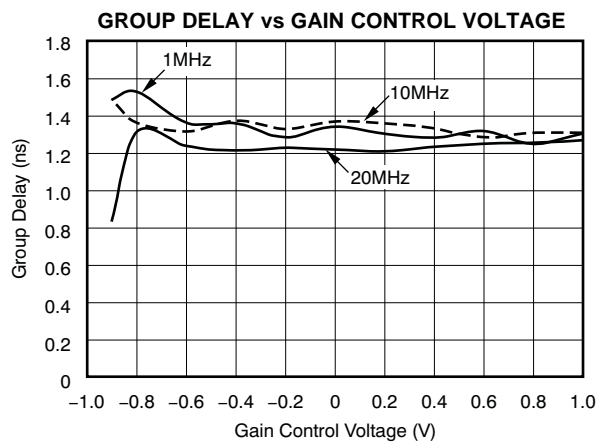

Figure 30.

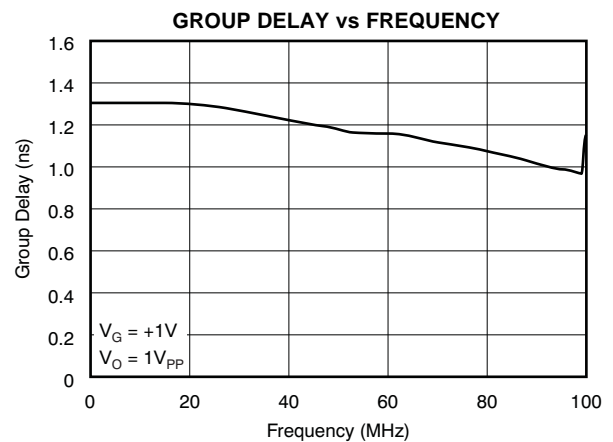

Figure 31.

TYPICAL CHARACTERISTICS: $V_S = \pm 5V$, $A_{V_{MAX}} = +2V/V$ (continued)

At $T_A = +25^\circ C$, $R_L = 100\Omega$, $R_F = 1.33k\Omega$, $R_G = 1.33k\Omega$, $V_G = +1V$, V_{IN} = single-ended input on $+V_{IN}$ with $-V_{IN}$ at ground, and SO-14 package, unless otherwise noted.

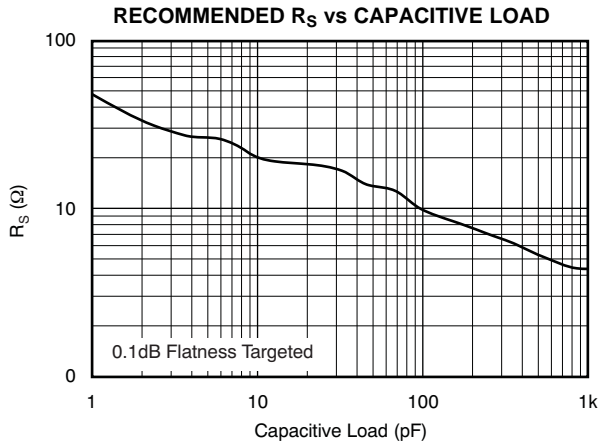

Figure 32.

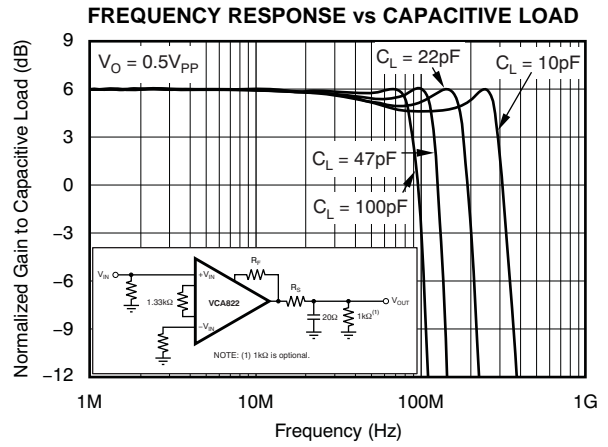

Figure 33.

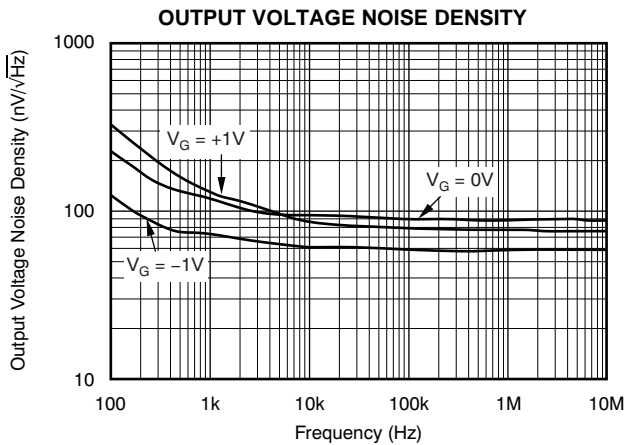

Figure 34.

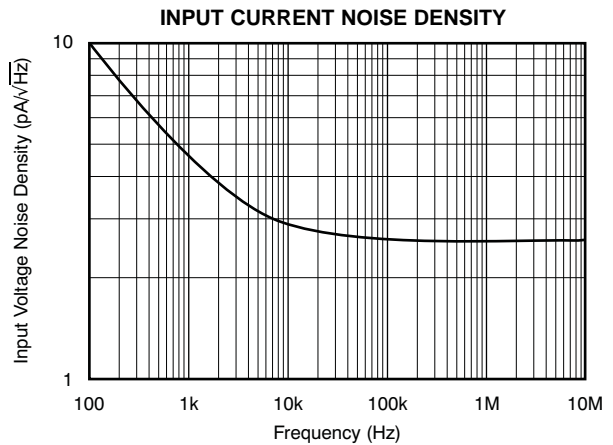

Figure 35.

TYPICAL CHARACTERISTICS: $V_S = \pm 5V$, $A_{VMAX} = +10V/V$

At $T_A = +25^\circ C$, $R_L = 100\Omega$, $R_F = 1k\Omega$, $R_G = 200\Omega$, $V_G = +1V$, and V_{IN} = single-ended input on $+V_{IN}$ with $-V_{IN}$ at ground, unless otherwise noted.

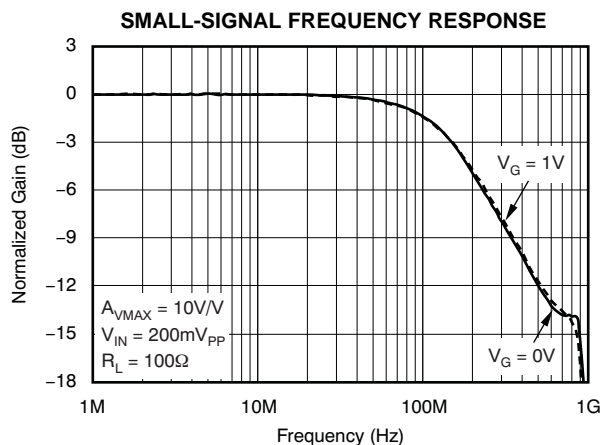

Figure 36.

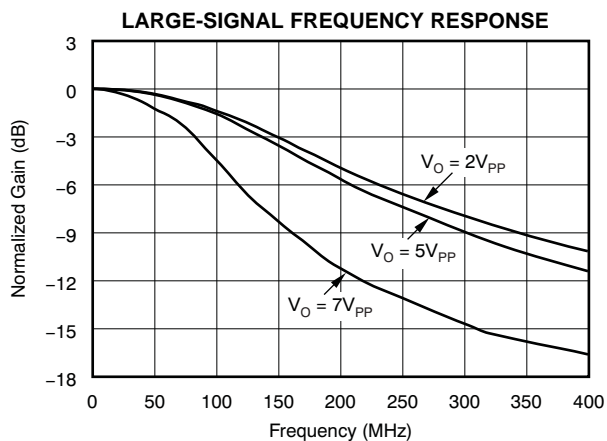

Figure 37.

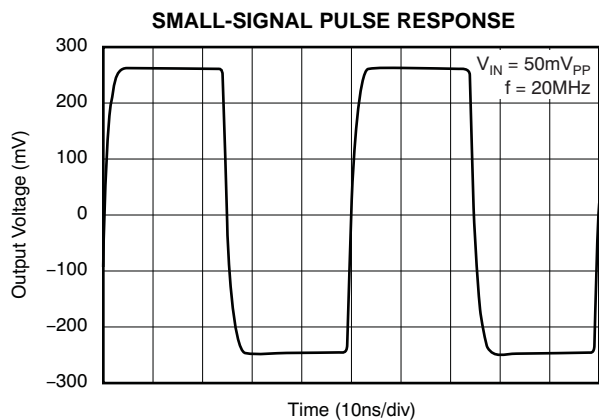

Figure 38.

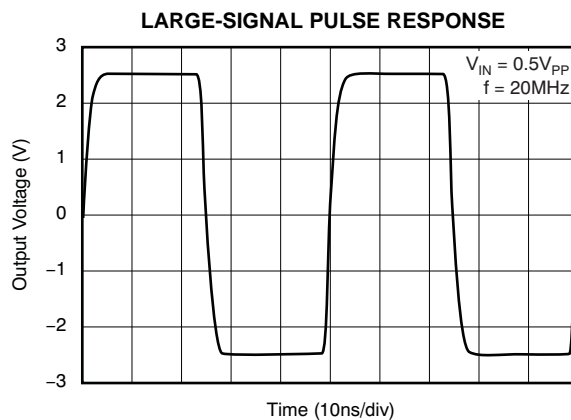

Figure 39.

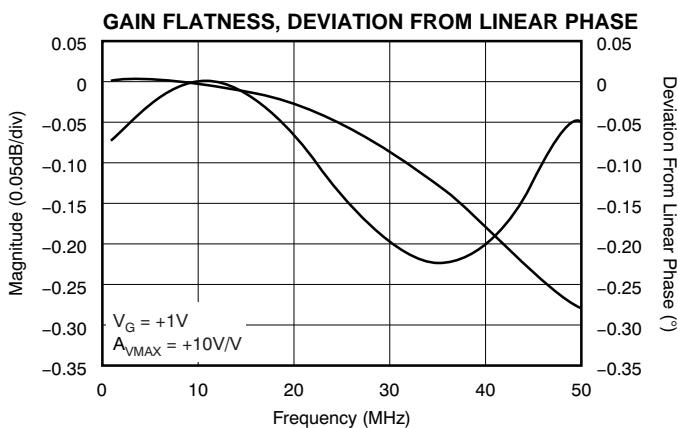

Figure 40.

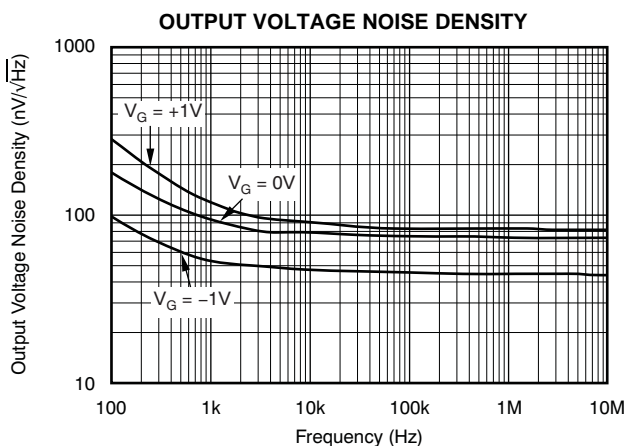

Figure 41.

TYPICAL CHARACTERISTICS: $V_S = \pm 5V$, $A_{VMAX} = +10V/V$ (continued)

At $T_A = +25^\circ C$, $R_L = 100\Omega$, $R_F = 1k\Omega$, $R_G = 200\Omega$, $V_G = +1V$, and V_{IN} = single-ended input on $+V_{IN}$ with $-V_{IN}$ at ground, unless otherwise noted.

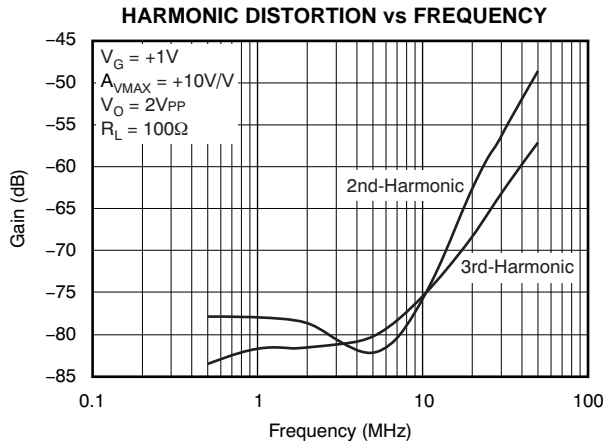

Figure 42.

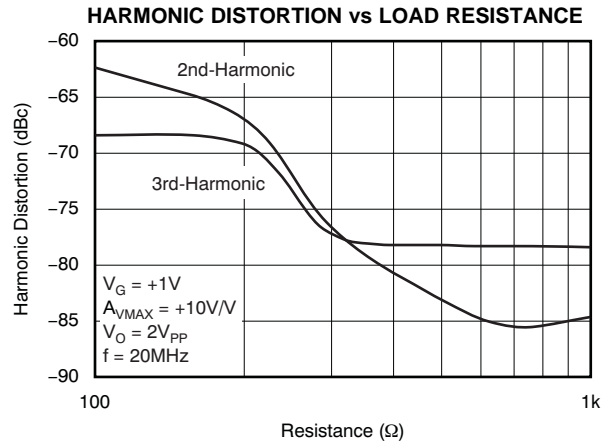

Figure 43.

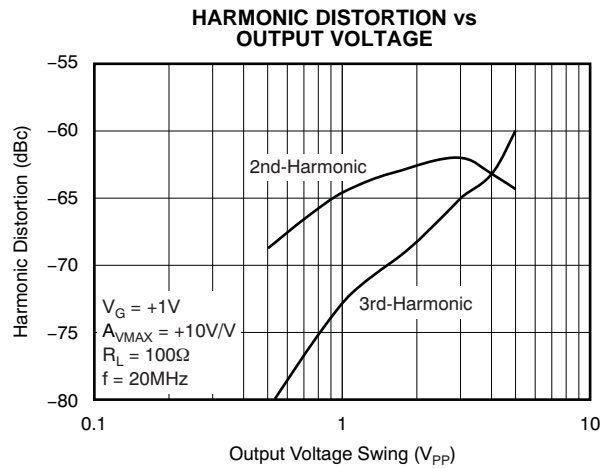

Figure 44.

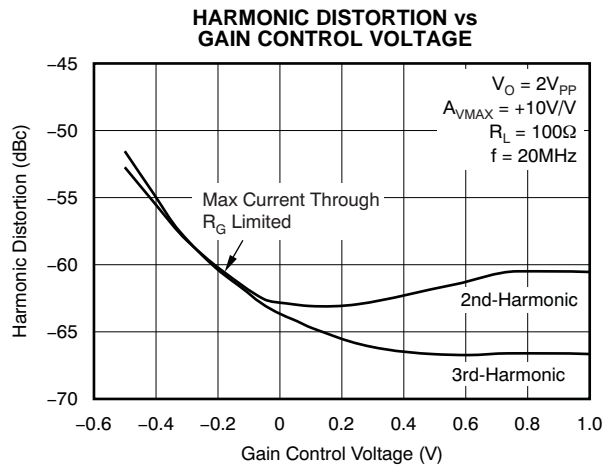

Figure 45.

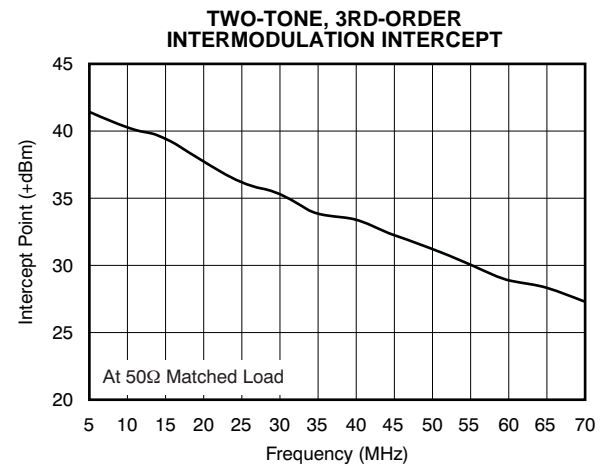

Figure 46.

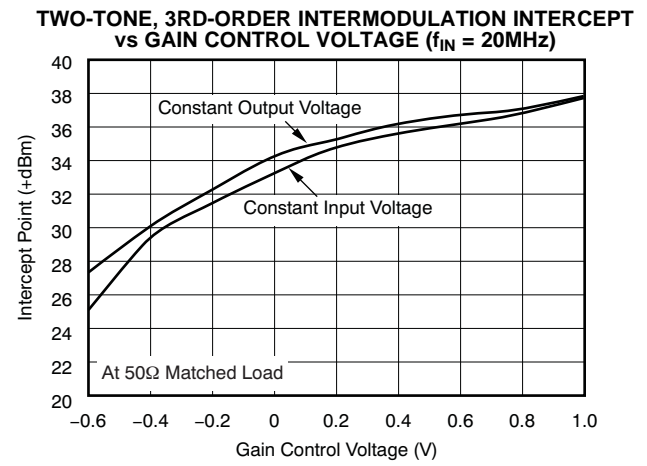

Figure 47.

TYPICAL CHARACTERISTICS: $V_S = \pm 5V$, $A_{VMAX} = +10V/V$ (continued)

At $T_A = +25^\circ C$, $R_L = 100\Omega$, $R_F = 1k\Omega$, $R_G = 200\Omega$, $V_G = +1V$, and $V_{IN} =$ single-ended input on $+V_{IN}$ with $-V_{IN}$ at ground, unless otherwise noted.

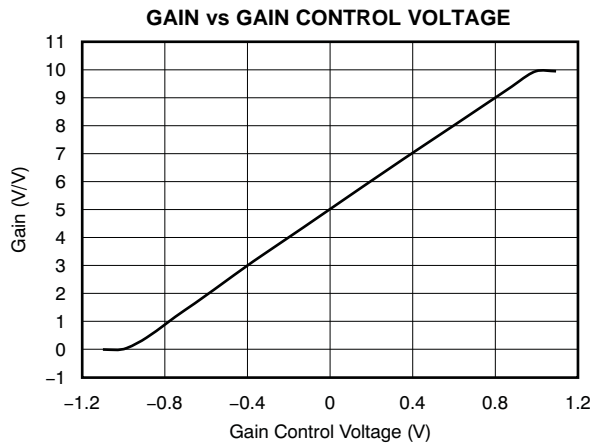

Figure 48.

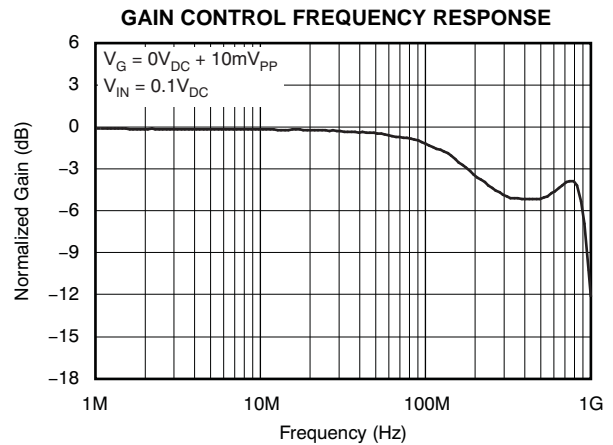

Figure 49.

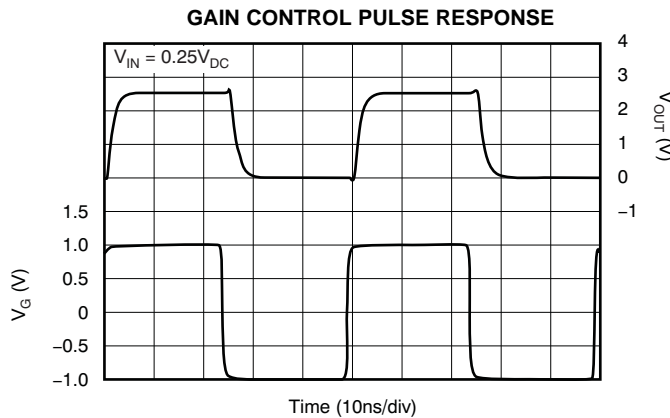

Figure 50.

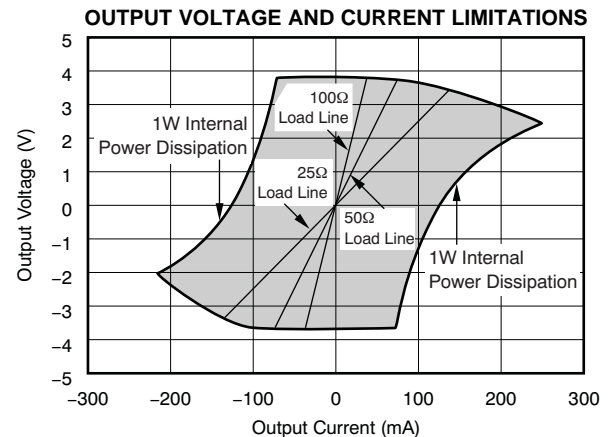

Figure 51.

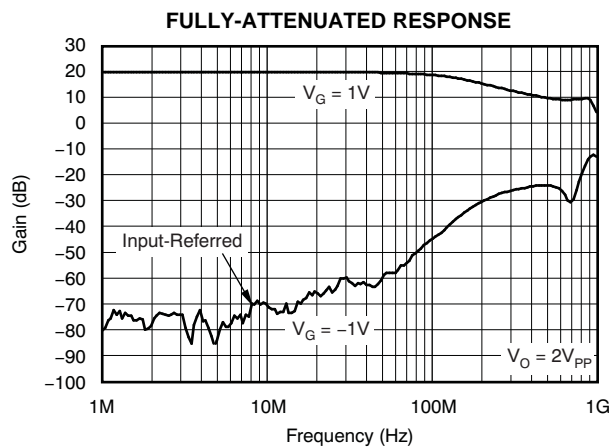

Figure 52.

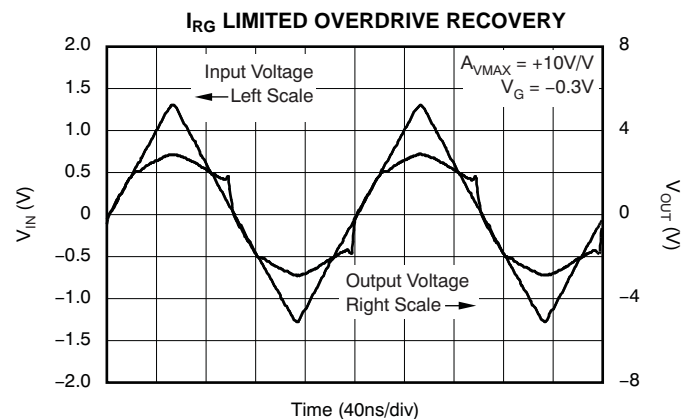

Figure 53.

TYPICAL CHARACTERISTICS: $V_S = \pm 5V$, $A_{VMAX} = +10V/V$ (continued)

At $T_A = +25^\circ C$, $R_L = 100\Omega$, $R_F = 1k\Omega$, $R_G = 200\Omega$, $V_G = +1V$, and V_{IN} = single-ended input on $+V_{IN}$ with $-V_{IN}$ at ground, unless otherwise noted.

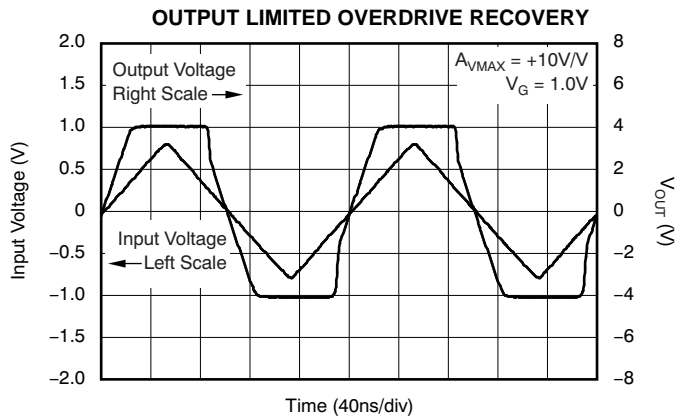

Figure 54.

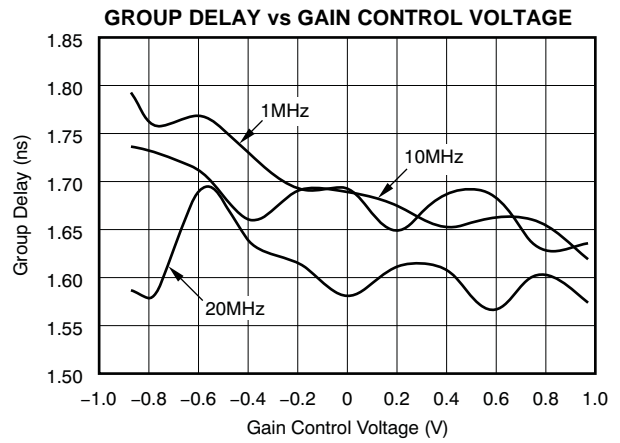

Figure 55.

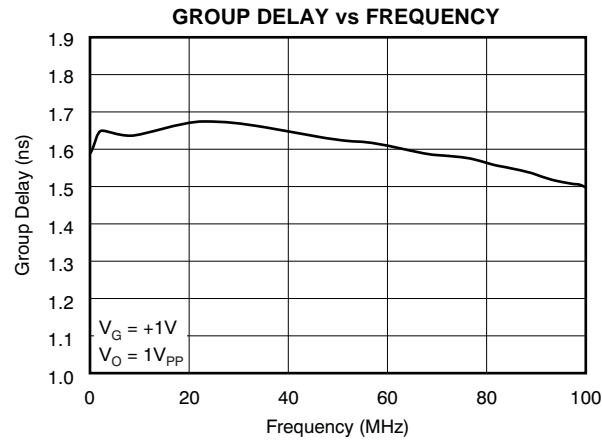

Figure 56.

TYPICAL CHARACTERISTICS: $V_S = \pm 5V$, $A_{VMAX} = +100V/V$

At $T_A = +25^\circ C$, $R_L = 100\Omega$, $R_F = 845\Omega$, $R_G = 16.9\Omega$, $V_G = +1V$, V_{IN} = single-ended input on $+V_{IN}$ with $-V_{IN}$ at ground, and SO-14 package, unless otherwise noted.

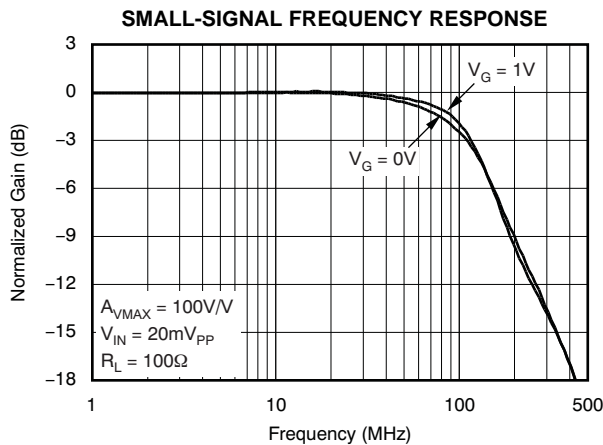

Figure 57.

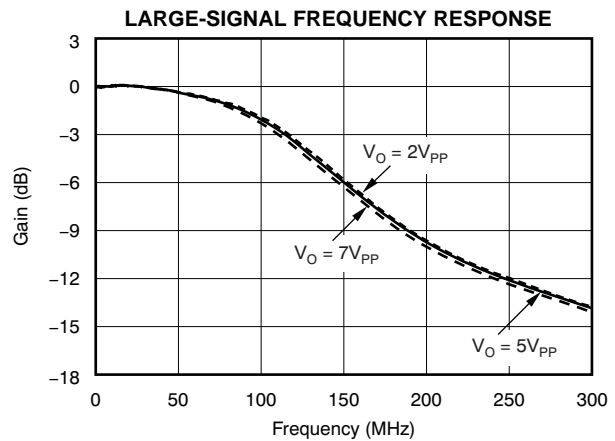

Figure 58.

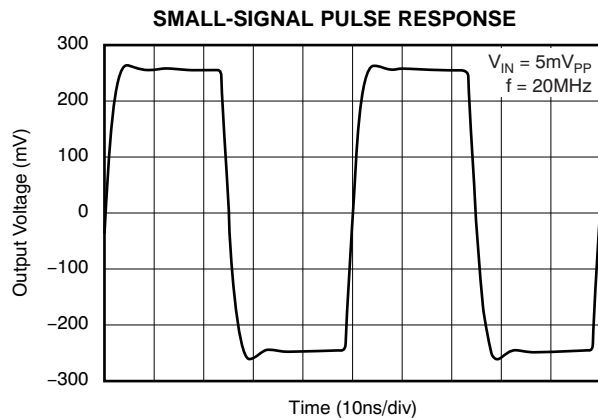

Figure 59.

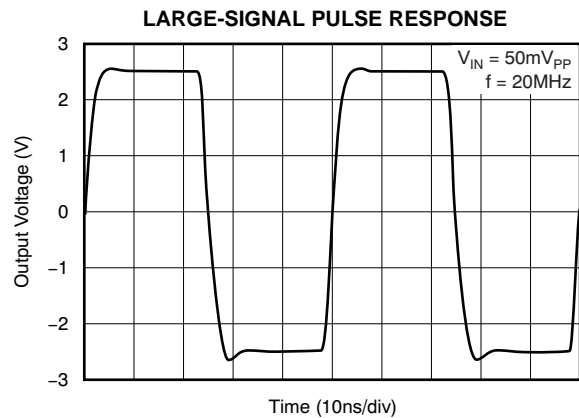

Figure 60.

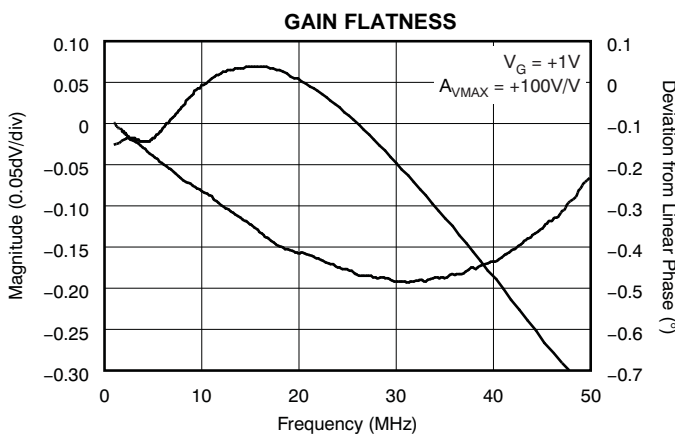

Figure 61.

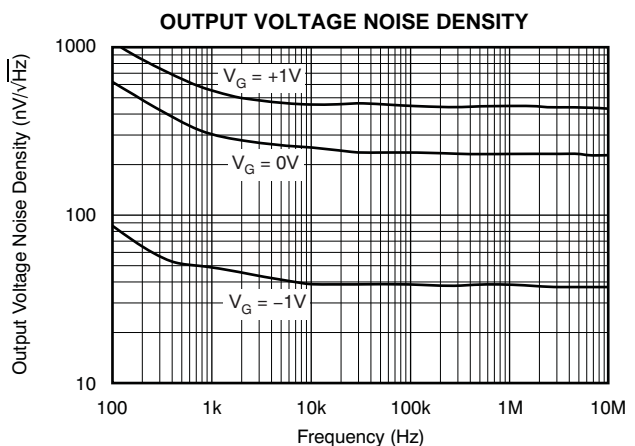

Figure 62.

TYPICAL CHARACTERISTICS: $V_S = \pm 5V$, $A_{VMAX} = +100V/V$ (continued)

At $T_A = +25^\circ C$, $R_L = 100\Omega$, $R_F = 845\Omega$, $R_G = 16.9\Omega$, $V_G = +1V$, V_{IN} = single-ended input on $+V_{IN}$ with $-V_{IN}$ at ground, and SO-14 package, unless otherwise noted.

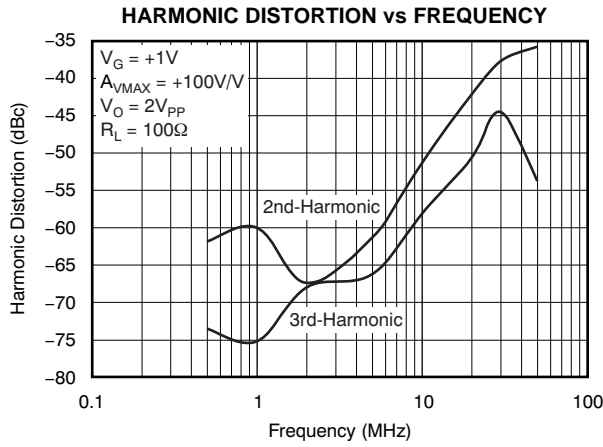

Figure 63.

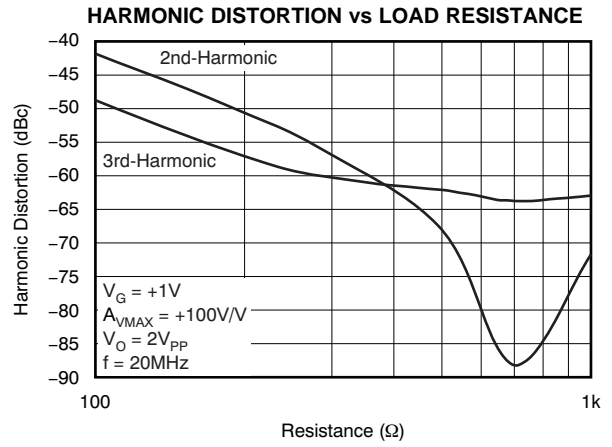

Figure 64.

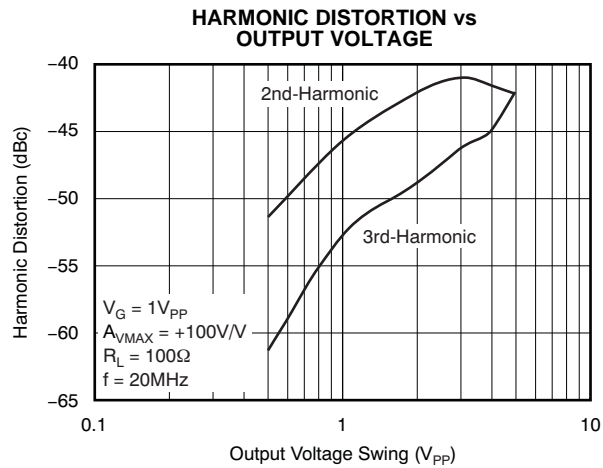

Figure 65.

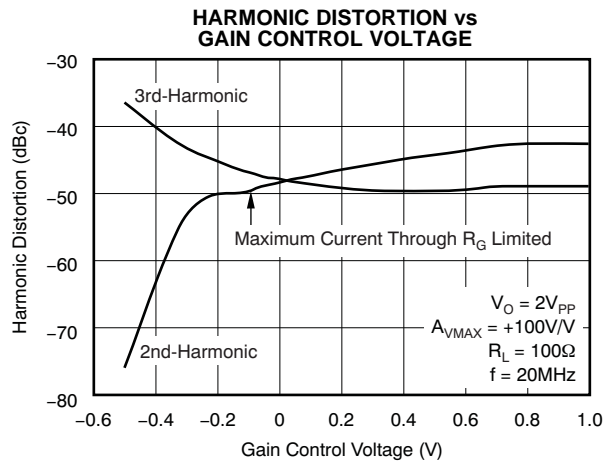

Figure 66.

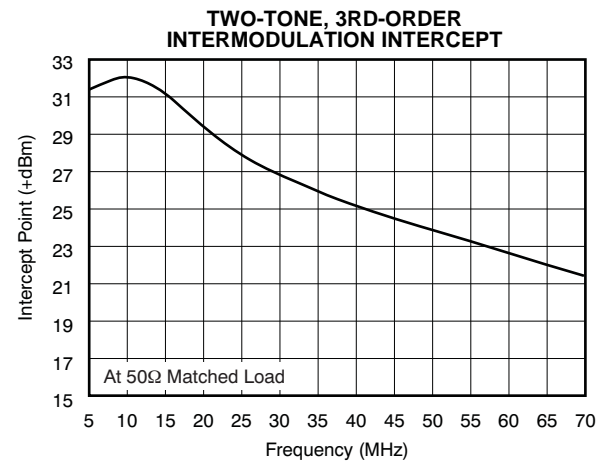

Figure 67.

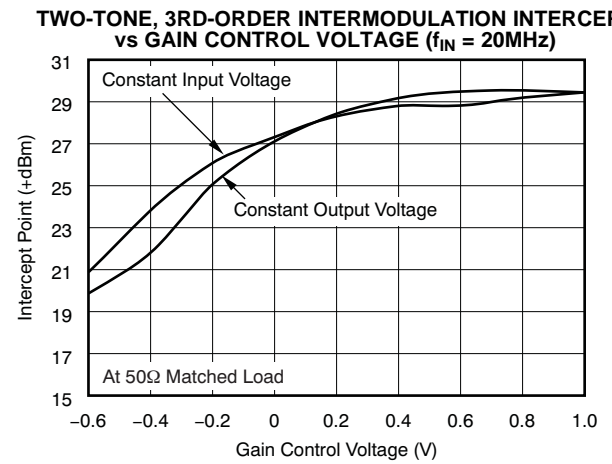

Figure 68.

TYPICAL CHARACTERISTICS: $V_S = \pm 5V$, $A_{VMAX} = +100V/V$ (continued)

At $T_A = +25^\circ C$, $R_L = 100\Omega$, $R_F = 845\Omega$, $R_G = 16.9\Omega$, $V_G = +1V$, V_{IN} = single-ended input on $+V_{IN}$ with $-V_{IN}$ at ground, and SO-14 package, unless otherwise noted.

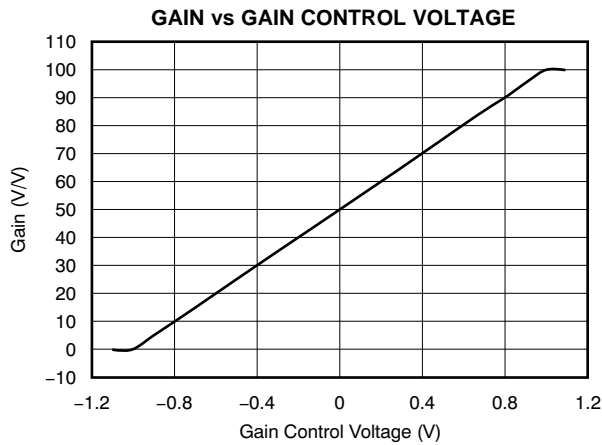

Figure 69.

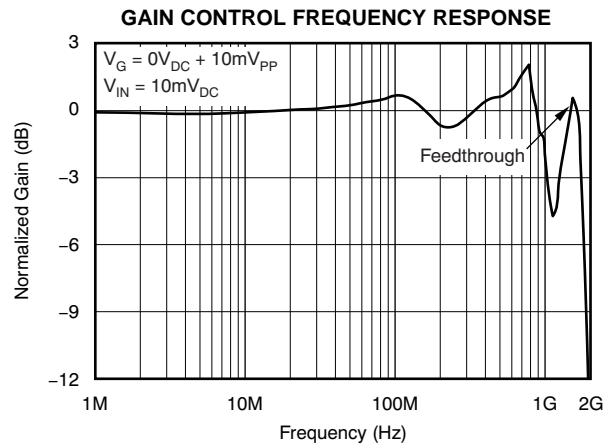

Figure 70.

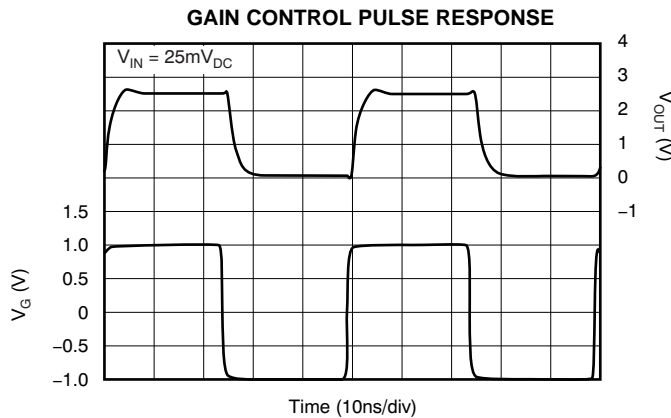

Figure 71.

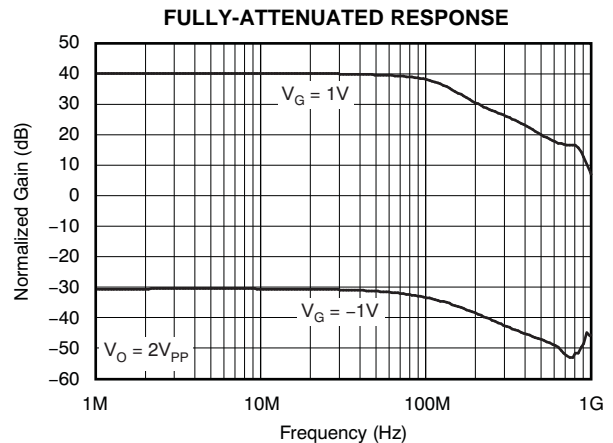

Figure 72.

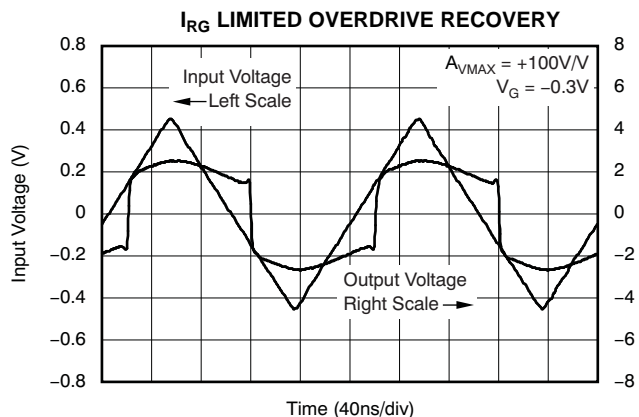

Figure 73.

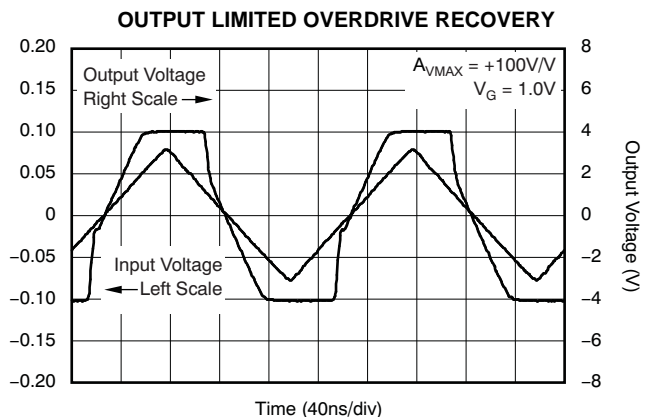

Figure 74.

TYPICAL CHARACTERISTICS: $V_S = \pm 5V$, $A_{VMAX} = +100V/V$ (continued)

At $T_A = +25^\circ C$, $R_L = 100\Omega$, $R_F = 845\Omega$, $R_G = 16.9\Omega$, $V_G = +1V$, V_{IN} = single-ended input on $+V_{IN}$ with $-V_{IN}$ at ground, and SO-14 package, unless otherwise noted.

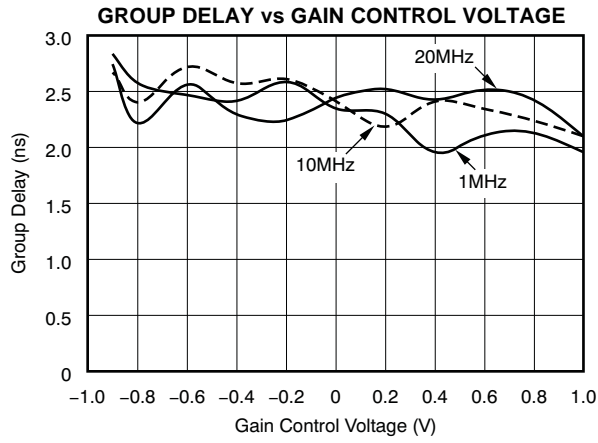

Figure 75.

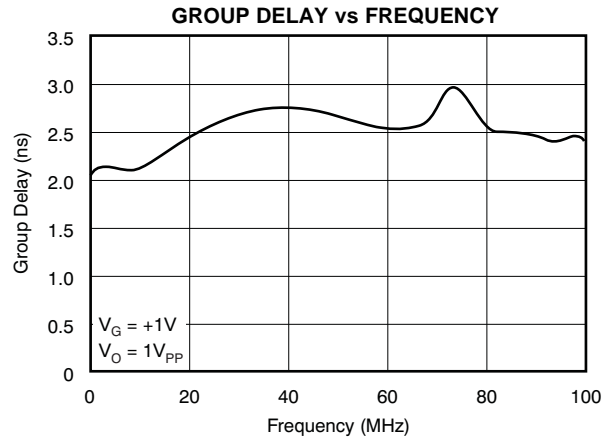

Figure 76.

APPLICATION INFORMATION

WIDEBAND VARIABLE GAIN AMPLIFIER OPERATION

The VCA822 provides an exceptional combination of high output power capability with a wideband, greater than 40dB gain adjust range, linear in V/V variable gain amplifier. The VCA822 input stage places the transconductance element between two input buffers, using the output currents as the forward signal. As the differential input voltage rises, a signal current is generated through the gain element. This current is then mirrored and gained by a factor of two before reaching the multiplier. The other input of the multiplier is the voltage gain control pin, V_G . Depending on the voltage present on V_G , up to two times the gain current is provided to the transimpedance output stage. The transimpedance output stage is a current-feedback amplifier providing high output current capability and high slew rate, 1700V/ μ s. This exceptional full-power performance comes at the price of a relatively high quiescent current (36mA), but a low input voltage noise for this type of architecture (8.2nV/ $\sqrt{\text{Hz}}$).

Figure 77 shows the dc-coupled, gain of +10V/V, dual power-supply circuit used as the basis of the ± 5 V Electrical Characteristics and Typical Characteristics.

For test purposes, the input impedance is set to 50 Ω with a resistor to ground and the output impedance is set to 50 Ω with a series output resistor. Voltage swings reported in the Electrical Characteristics table are taken directly at the input and output pins, while output power (dBm) is at the matched 50 Ω load. For the circuit in Figure 77, the total effective load is 100 Ω || 1k Ω . Note that for the SO-14 package, there is a voltage reference pin, V_{REF} (pin 9). For the SO-14 package, this pin must be connected to ground through a 20 Ω resistor in order to avoid possible oscillations of the output stage. In the MSOP-10 package, this pin is internally connected and does not require such precaution. An X2Y™ capacitor has been used for power-supply bypassing. The combination of low inductance, high resonance frequency, and integration of three capacitors in one package (two capacitors to ground and one across the supplies) of this capacitor enables to achieve the low second-harmonic distortion reported in the Electrical Characteristics table. More information on how the VCA822 operates can be found in the Operating Suggestions section.

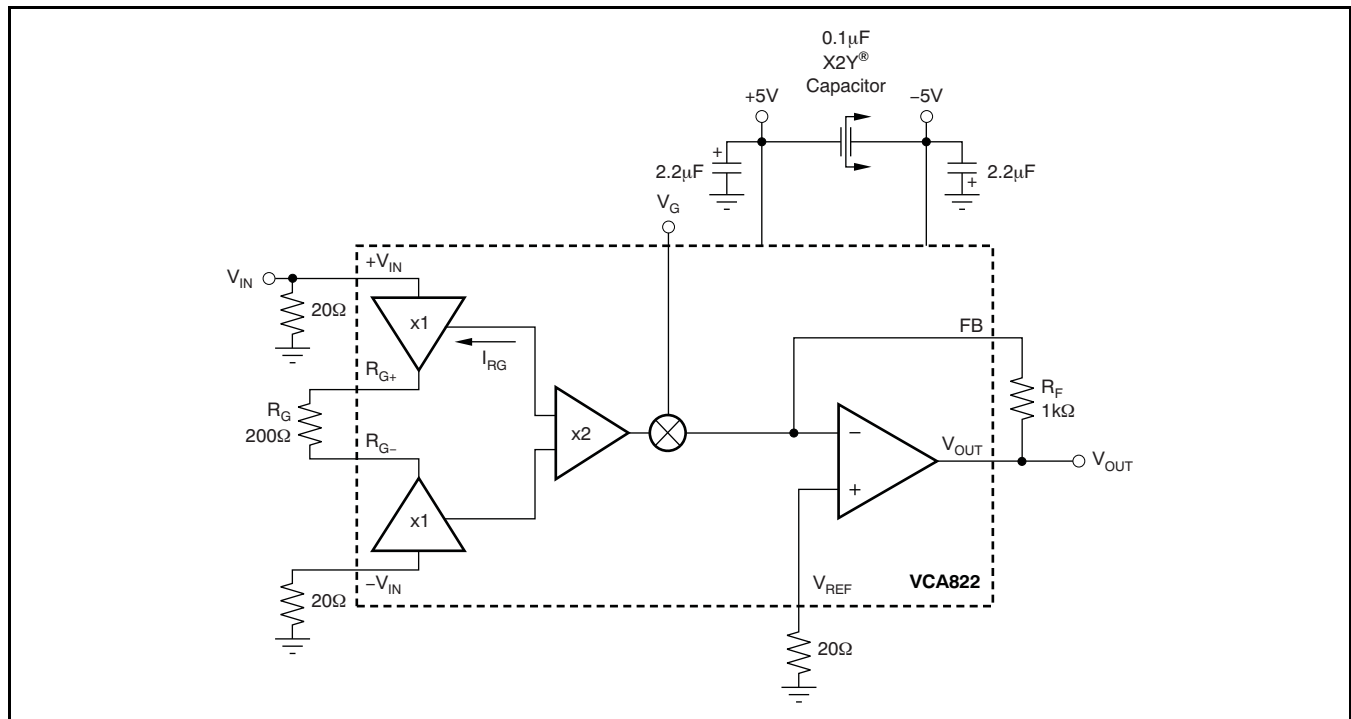

Figure 77. DC-Coupled, $A_{V_{MAX}} = +10\text{V/V}$, Bipolar Supply Specification and Test Circuit

FOUR-QUADRANT MULTIPLIER

A four-quadrant multiplier can easily be implemented using the VCA822. By placing a resistor between FB and V_{IN} , the transfer function depends upon both V_{IN} and V_G , as shown in Equation 1.

$$V_{OUT} = \frac{R_F}{R_G} \times V_G \times V_{IN} + \left[\frac{R_F}{R_G} - \frac{R_F}{R_1} \right] \times V_{IN} \tag{1}$$

Setting R_1 to equal R_G , the term that depends only on V_{IN} drops out of the equation, leaving only the term that depends on both V_G and V_{IN} . V_{OUT} then follows Equation 2.

$$V_{OUT} = \frac{R_F}{R_G} \times V_{IN} \times V_G \tag{2}$$

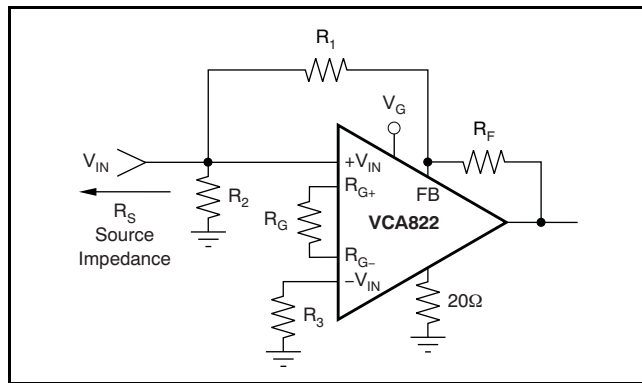

Figure 78. Four-Quadrant Multiplier Circuit

The behavior of this circuit is illustrated in Figure 79. Keeping the input amplitude of a 1MHz signal constant and varying the V_G voltage (100kHz, 2V_{PP}) gives the modulated output voltage shown in Figure 79.

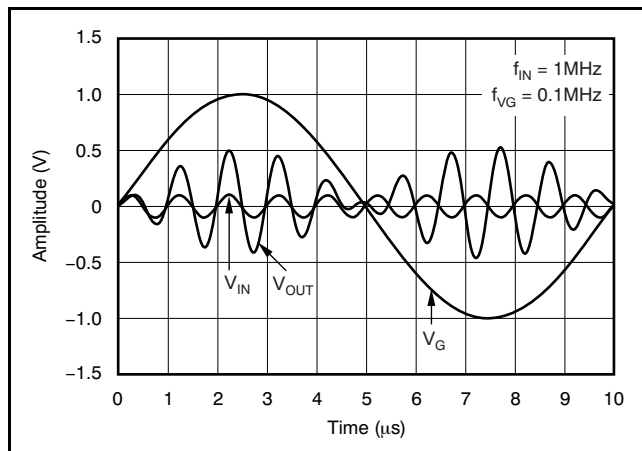

Figure 79. Modulated Output Signal of the 4-Quadrant Multiplier Circuit

DIFFERENCE AMPLIFIER

Because both inputs of the VCA822 are high-impedance, a difference amplifier can be implemented without any major problem. This implementation is shown in Figure 80. This circuit provides excellent common-mode rejection ratio (CMRR) as long as the input is within the CMRR range of $-2.1V$ to $+1.6V$. Note that this circuit does not make use of the gain control pin, V_G . Also, it is recommended to choose R_S such that the pole formed by R_S and the parasitic input capacitance does not limit the bandwidth of the circuit. The common-mode rejection ratio for this circuit implemented in a gain of $+10V/V$ for $V_G = +1V$ is shown in Figure 81. Note that because the gain control voltage is fixed and is normally set to $+1V$, the feedback element can be reduced in order to increase the bandwidth. When reducing the feedback element make sure that the VCA822 is not limited by common-mode input voltage, the current flowing through R_G , or any other limitation described in this data sheet.

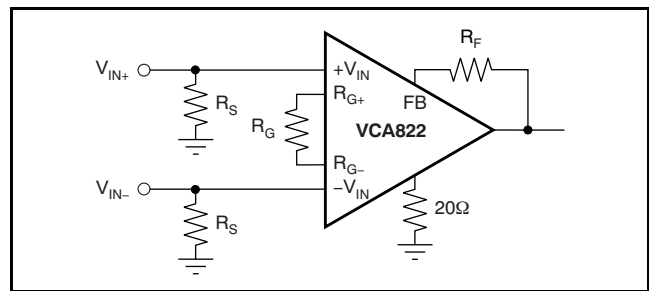

Figure 80. Difference Amplifier

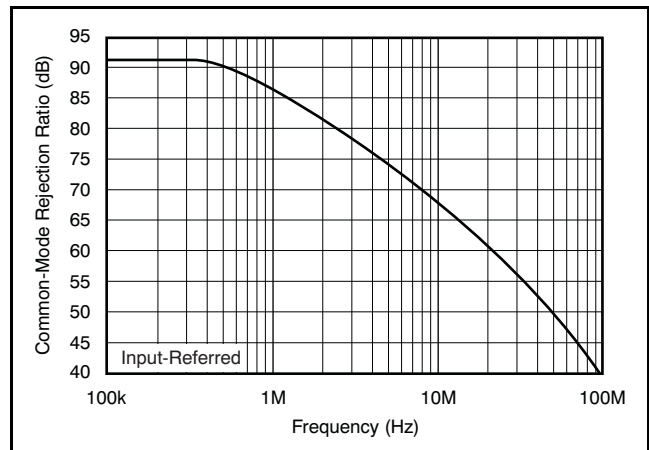

Figure 81. Common-Mode Rejection Ratio

DIFFERENTIAL EQUALIZER

If the application requires frequency shaping (the transition from one gain to another), the VCA822 can be used advantageously because its architecture allows the application to isolate the input from the gain setting elements. Figure 82 shows an implementation of such a configuration. The transfer function is shown in Equation 3.

$$G = 2 \times \frac{R_F}{R_G} \times \frac{1 + sR_G C_1}{1 + sR_1 C_1} \quad (3)$$

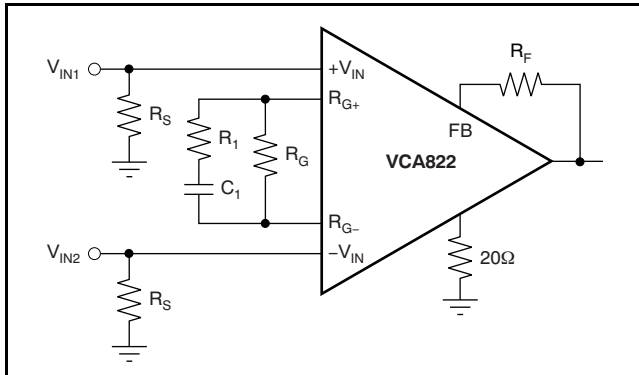

Figure 82. Differential Equalizer

This transfer function has one pole, P_1 (located at $R_G C_1$), and one zero, Z_1 (located at $R_1 C_1$). When equalizing an RC load, R_L and C_L , compensate the pole added by the load located at $R_L C_L$ with the zero Z_1 . Knowing R_L , C_L , and R_G allows the user to select C_1 as a first step and then calculate R_1 . Using $R_L = 75\Omega$, $C_L = 100\text{pF}$ and wanting the VCA822 to operate at a gain of $+2V/V$, which gives $R_F = R_G = 1.33\text{k}\Omega$, allows the user to select $C_1 = 5\text{pF}$ to ensure a positive value for the resistor R_1 . With all these values known, R_1 can be calculated to be 170Ω . The frequency response for both the initial, unequaled frequency response and the resulting equalized frequency response are shown in Figure 83.

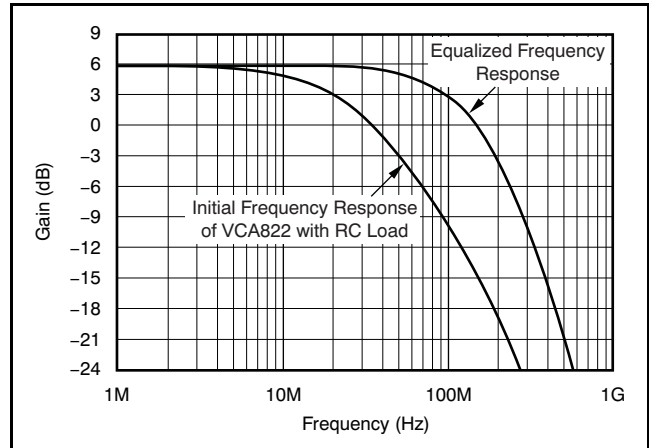

Figure 83. Differential Equalization of an RC Load

DIFFERENTIAL CABLE EQUALIZER

A differential cable equalizer can easily be implemented using the VCA822. An example of a cable equalization for 100 feet of Belden Cable 1694F is illustrated in Figure 85, with the result for this implementation shown in Figure 84. This implementation has a maximum error of 0.2dB from dc to 40MHz.

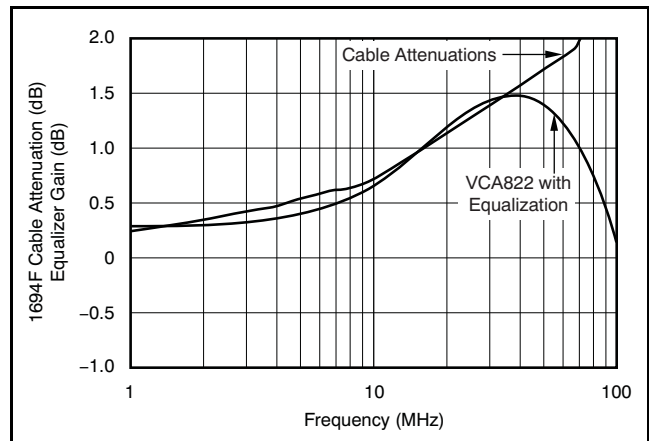

Figure 84. Cable Attenuation versus Equalizer Gain

Note that this implementation shows the cable attenuation side-by-side with the equalization in the same plot. For a given frequency, the equalization function realized with the VCA822 matches the cable attenuation. The circuit in Figure 85 is a driver circuit. To implement a receiver circuit, the signal is received differentially between the $+V_{IN}$ and $-V_{IN}$ inputs.

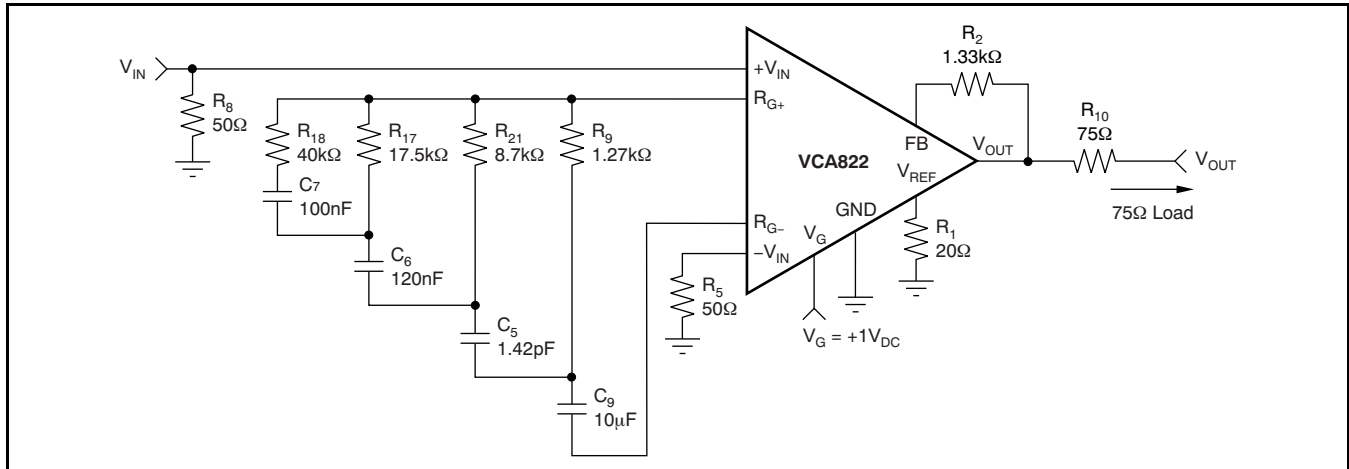

Figure 85. Differential Cable Equalizer

VOLTAGE-CONTROLLED LOW-PASS FILTER

In the circuit of [Figure 86](#), the VCA822 serves as the variable-gain element of a voltage-controlled low-pass filter. This section discusses how this implementation expands the circuit voltage swing capability over that normally achieved with the equivalent multiplier implementation. The circuit control voltage, V_G , is calculated as according to the simplified relationship in [Equation 4](#):

$$\frac{V_{OUT}}{V_{IN}} = -\frac{R_2}{R_1} \times \frac{1}{1 + s \frac{R_2 C}{G}} \quad (4)$$

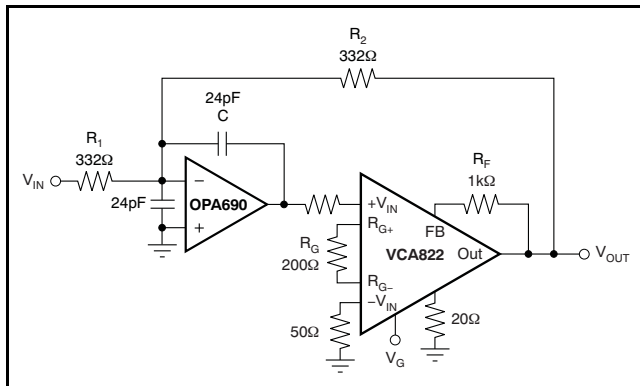

Figure 86. Voltage-Control Low-Pass Filter

The response control results from amplification of the feedback voltage applied to R_2 . First, consider the case where the VCA822 produces $G = 1V/V$. Then

this circuit performs as if the amplifier were replaced by a short circuit. Visually replacing the amplifier by a short leaves a simple voltage-feedback amplifier with a feedback resistor bypassed by a capacitor. Replacing this gain with a variable gain, G , the pole can be written as shown in [Equation 5](#):

$$f_8 = \frac{G}{2\pi R_2 C} \quad (5)$$

Because the VCA822 is most linear in the midrange, the median of the adjustable pole should be set at $V_G = 0V$ (see [Figure 26](#), [Figure 46](#), [Figure 67](#), and [Equation 6](#)). Selecting $R_1 = R_2 = 332\Omega$, and targeting a median frequency of 10MHz, the capacitance (C) is 24pF. Because the OPA690 was selected for the circuit of [Figure 86](#), and in order to limit peaking in the OPA690 frequency response, a capacitor equal to C was added on the inverting mode to ground. This architecture has the effect of setting the high-frequency noise gain of the OPA690 to $+2V/V$, ensuring stability and providing flat frequency response.

$$-0.8V \leq V_G \leq 0.8V \quad (6)$$

Once the median frequency is set, the maximum and minimum frequencies can be determined by using $V_G = -0.8V$ and $V_G = +0.8V$ in the gain equation of [Equation 7](#). Note that this is a first-order analysis and does not take into consideration the open-loop gain limitation of the OPA690.

$$G = 2 \times \frac{R_F}{R_G} \times \frac{V_G + 1}{2} \quad (7)$$

With the components shown, the circuit provides a linear variation of the low-pass cutoff from 2MHz to 20MHz, using $-1V \leq V_G \leq +1V$. Practical evaluation shows that this circuit works from 8MHz to 16MHz with $-0.8V < V_G < +0.8V$, as shown in [Figure 87](#).

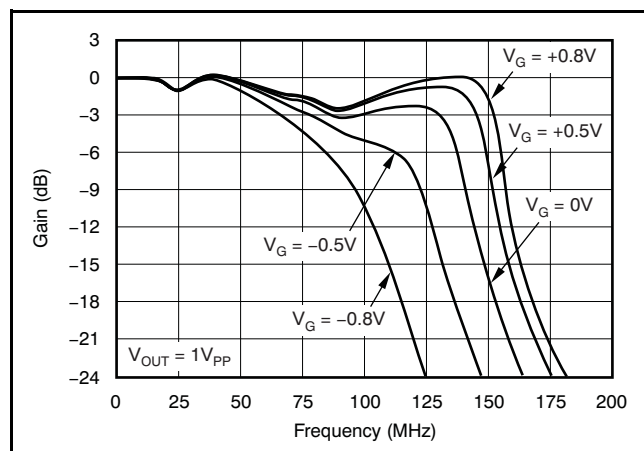

Figure 87. VCA822 as a Voltage-Control, Low-Pass Filter

DESIGN-IN TOOLS

DEMONSTRATION BOARDS

Two printed circuit boards (PCBs) are available to assist in the initial evaluation of circuit performance using the VCA822 in its two package options. Both of these are offered free of charge as unpopulated PCBs, delivered with a user's guide. The summary information for these fixtures is shown in [Table 2](#).

Table 2. EVM Ordering Information

PRODUCT	PACKAGE	BOARD PART NUMBER	LITERATURE REQUEST NUMBER
VCA822ID	SO-14	DEM-VCA-SO-1B	SBOU050
VCA822IDGS	MSOP-10	DEM-VCA-MSOP-1A	SBOU051

The demonstration fixtures can be requested at the Texas Instruments web site (www.ti.com) through the VCA822 product folder.

MACROMODELS AND APPLICATIONS SUPPORT

Computer simulation of circuit performance using SPICE is often useful when analyzing the performance of analog circuits and systems. This principle is particularly true for video and RF amplifier circuits where parasitic capacitance and inductance can play a major role in circuit performance. A [SPICE model](#) for the VCA822 is available through the TI web page. The applications group is also available for design assistance. The models available from TI predict typical small-signal ac performance, transient steps, dc performance, and noise under a wide variety of operating conditions. The models include the noise terms found in the electrical specifications of the relevant product data sheet.

OPERATING SUGGESTIONS

Operating the VCA822 optimally for a specific application requires trade-offs between bandwidth, input dynamic range and the maximum input voltage, the maximum gain of operation and gain, output dynamic range and the maximum input voltage, the package used, loading, and layout and bypass recommendations. The [Typical Characteristics](#) have been defined to cover as much ground as possible to describe the VCA822 operation. There are four sections in the Typical Characteristics:

- $V_S = \pm 5V$ [DC Parameters](#) and $V_S = \pm 5V$ [DC and Power-Supply Parameters](#), which include dc operation and the intrinsic limitation of a VCA822 design
- $V_S = \pm 5V$, $A_{VMAX} = +2V/V$ [Gain of +2V/V Operation](#)
- $V_S = \pm 5V$, $A_{VMAX} = +10V/V$ [Gain of +10V/V Operation](#)
- $V_S = \pm 5V$, $A_{VMAX} = +100V/V$ [Gain of +100V/V Operation](#)

Where the Typical Characteristics describe the actual performance that can be achieved by using the amplifier properly, the following sections describe in detail the trade-offs needed to achieve this level of performance.

PACKAGE CONSIDERATIONS

The VCA822 is available in both SO-14 and MSOP-10 packages. Each package has, for the different gains used in the typical characteristics, different values of R_F and R_G in order to achieve the same performance detailed in the [Electrical Characteristics](#) table.

Figure 88 shows a test gain circuit for the VCA822. Table 3 lists the recommended configuration for the SO-14 and MSOP-10 package.

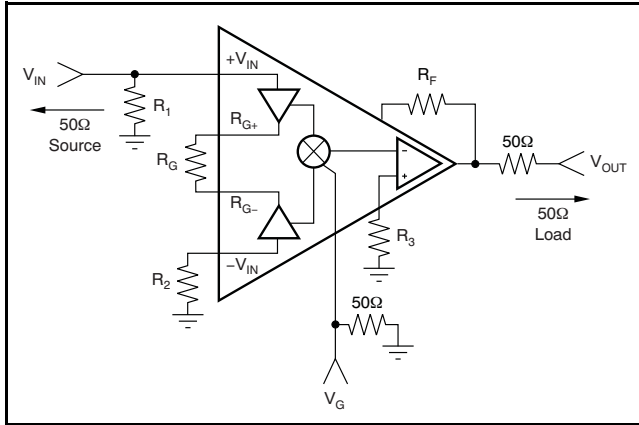

Figure 88. Test Circuit

Table 3. SO-14 and MSOP-10 R_F and R_G Configurations

	G = 2	G = 10	G = 100
R_F	1.33k Ω	1k Ω	845 Ω
R_G	1.33k Ω	200 Ω	16.9 Ω

There are no differences between the packages in the recommended values for the gain and feedback resistors. However, the bandwidth for the VCA822IDGS (MSOP-10 package) is lower than the bandwidth for the VCA822ID (SO-14 package). This difference is true for all gains, but especially true for gains greater than 5V/V, as can be seen in Figure 89 and Figure 90. Note that the scale must be changed to a linear scale to view the details.

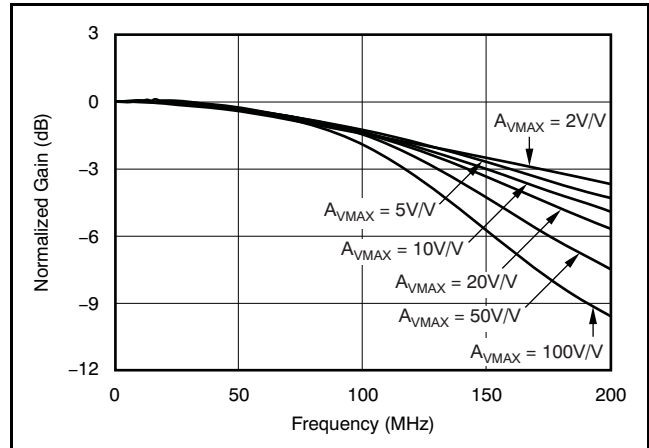

Figure 89. SO-14 Recommended R_F and R_G versus A_{VMAX}

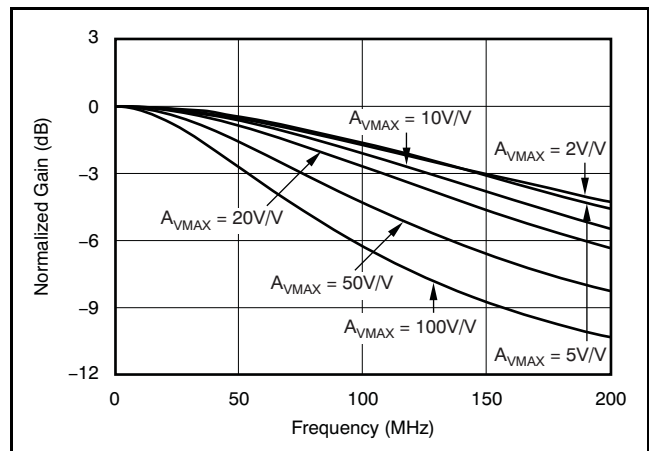

Figure 90. MSOP-10 Recommended R_F and R_G versus A_{VMAX}

MAXIMUM GAIN OF OPERATION

This section describes the use of the VCA822 in a fixed-gain application in which the V_G control pin is set at $V_G = +1V$. The tradeoffs described here are with bandwidth, gain, and output voltage range.

In the case of an application that does not make use of the V_{GAIN} , but requires some other characteristic of the VCA822, the R_G resistor must be set such that the maximum current flowing through the resistance I_{RG} is less than $\pm 2.6mA$ typical, or $5.2mA_{PP}$ as defined in the [Electrical Characteristics](#) table, and must follow Equation 8.

$$I_{RG} = \frac{V_{OUT}}{A_{VMAX} \times R_G} \tag{8}$$

As illustrated in [Equation 8](#), once the output dynamic range and maximum gain are defined, the gain resistor is set. This gain setting in turn affects the bandwidth, because in order to achieve the gain (and with a set gain element), the feedback element of the output stage amplifier is set as well. Keeping in mind that the output amplifier of the VCA822 is a current-feedback amplifier, the larger the feedback element, the lower the bandwidth as the feedback resistor is the compensation element.

Limiting the discussion to the input voltage only and ignoring the output voltage and gain, [Figure 3](#) illustrates the tradeoff between the input voltage and the current flowing through the gain resistor.

OUTPUT CURRENT AND VOLTAGE

The VCA822 provides output voltage and current capabilities that are unsurpassed in a low-cost monolithic VCA. Under no-load conditions at +25°C, the output voltage typically swings closer than 1V to either supply rails; the +25°C swing limit is within 1.2V of either rails. Into a 15Ω load (the minimum tested load), it is tested to deliver more than ±160mA.

The specifications described above, though familiar in the industry, consider voltage and current limits separately. In many applications, it is the voltage × current, or *V-I product*, that is more relevant to circuit operation. Refer to the *Output Voltage and Current Limitations* plot ([Figure 51](#)) in the Typical Characteristics. The X- and Y-axes of this graph show the zero-voltage output current limit and the zero-current output voltage limit, respectively. The four quadrants give a more detailed view of the VCA822 output drive capabilities, noting that the graph is bounded by a *Safe Operating Area* of 1W maximum internal power dissipation. Superimposing resistor load lines onto the plot shows that the VCA822 can drive ±2.5V into 25Ω or ±3.5V into 50Ω without exceeding the output capabilities or the 1W dissipation limit. A 100Ω load line (the standard test circuit load) shows the full ±3.9V output swing capability, as shown in the [Typical Characteristics](#).

The minimum specified output voltage and current over-temperature are set by worst-case simulations at the cold temperature extreme. Only at cold startup do the output current and voltage decrease to the numbers shown in the [Electrical Characteristic](#) tables. As the output transistors deliver power, the respective junction temperatures increase, increasing the available output voltage swing, and increasing the available output current. In steady-state operation, the available output voltage and current is always greater than that temperature shown in the over-temperature specifications because the output stage junction temperatures are higher than the specified operating ambient.

INPUT VOLTAGE DYNAMIC RANGE

The VCA822 has a input dynamic range limited to +1.6V and –2.1V. Increasing the input voltage dynamic range can be done by using an attenuator network on the input. If the VCA822 is trying to regulate the amplitude at the output, such as in an AGC application, the input voltage dynamic range is directly proportional to [Equation 9](#).

$$V_{IN(PP)} = R_G \times I_{RG(PP)} \quad (9)$$

As such, for unity-gain or under-attenuated conditions, the input voltage must be limited to the CMIR of ±1.6V (3.2V_{PP}) and the current (*I_{RQ}*) must flow through the gain resistor, ±2.6mA (5.2mA_{PP}). This configuration sets a minimum value for *R_E* such that the gain resistor has to be greater than [Equation 10](#).

$$R_{GMIN} = \frac{3.2V_{PP}}{5.2mA_{PP}} = 615.4\Omega \quad (10)$$

Values lower than 615.4Ω are gain elements that result in reduced input range, as the dynamic input range is limited by the current flowing through the gain resistor *R_G* (*I_{RG}*). If the *I_{RG}* current is limiting the performance of the circuit, the input stage of the VCA822 goes into overdrive, resulting in limited output voltage range. Such *I_{RG}*-limited overdrive conditions are shown in [Figure 53](#) for the gain of +10V/V and [Figure 73](#) for the +100V/V gain.

OUTPUT VOLTAGE DYNAMIC RANGE

With its large output current capability and its wide output voltage swing of ±3.9V typical on 100Ω load, it is easy to forget other types of limitations that the VCA822 can encounter. For these limitations, careful analysis must be done to avoid input stage limitation, either voltage or *I_{RG}* current; also, consider the gain limitation, as the control pin *V_G* varies, affecting other aspects of the circuit.

BANDWIDTH

The output stage of the VCA822 is a wideband current-feedback amplifier. As such, the feedback resistance is the compensation of the last stage. Reducing the feedback element and maintaining the gain constant limits the useful range of *I_{RG}*, and therefore reducing the gain adjust range. For a given gain, reducing the gain element limits the maximum achievable output voltage swing.

OFFSET ADJUSTMENT

As a result of the internal architecture used on the VCA822, the output offset voltage originates from the output stage and from the input stage and multiplier core. Figure 92 shows how to compensate both sources of the output offset voltage. Use this procedure to compensate the output offset voltage: starting with the output stage compensation, set $V_G = -1V$ to eliminate all offset contribution of the input stage and multiplier core. Adjust the output stage offset compensation potentiometer. Finally, set $V_G = +1V$ to the maximum gain and adjust the input stage and multiplier core potentiometer. This procedure effectively eliminates all offset contribution at the maximum gain. Because adjusting the gain modifies the contribution of the input stage and the multiplier core, some residual output offset voltage remains.

NOISE

The VCA822 offers $8.2nV/\sqrt{Hz}$ input-referred voltage noise density at a gain of $+10V/V$ and $1.8 pA/\sqrt{Hz}$ input-referred current noise density. The input-referred voltage noise density considers that all noise terms, except the input current noise but including the thermal noise of both the feedback resistor and the gain resistor, are expressed as one term.

This model is formulated in Equation 11 and Figure 91.

$$e_o = A_{VMAX} \times \sqrt{2 \times (R_S \times i_n)^2 + e_n^2 + 2 \times 4kTR_S} \quad (11)$$

A more complete model is shown in Figure 93. For additional information on this model and the actual modeled noise terms, please contact the High-Speed Product Application Support team at www.ti.com.

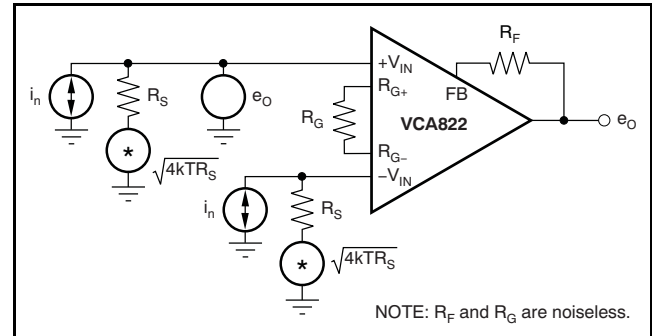

Figure 91. Simple Noise Model

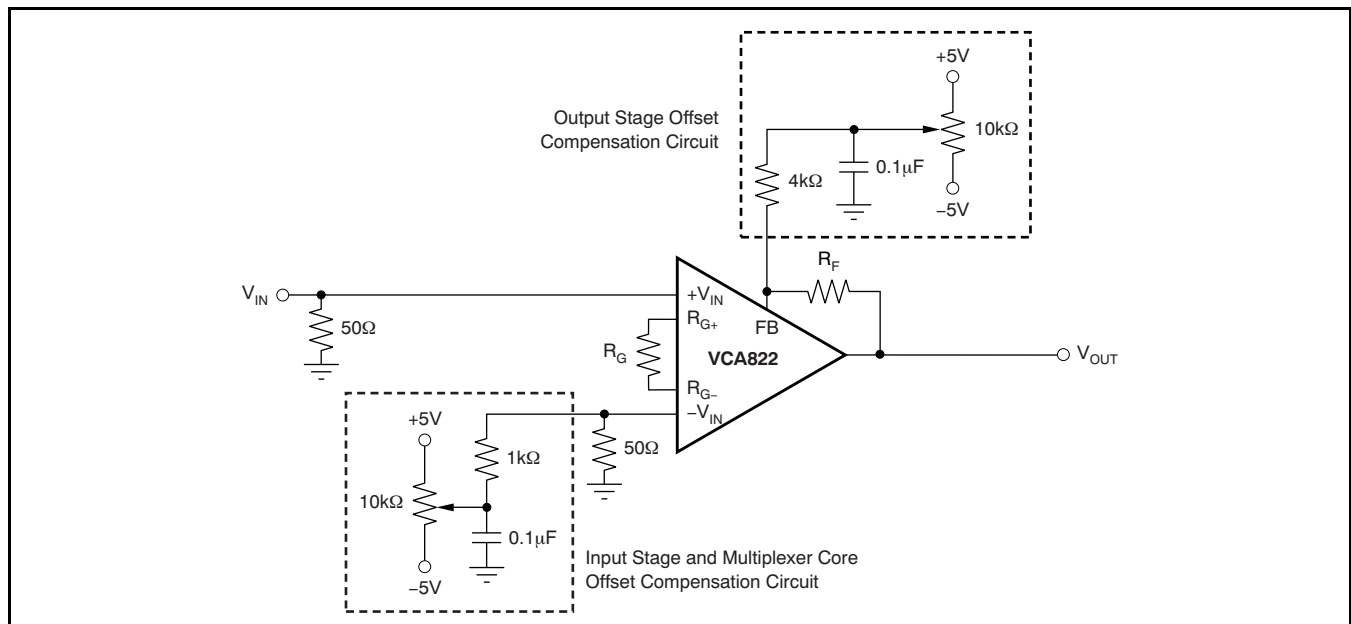

Figure 92. Adjusting the Input and Output Voltage Sources

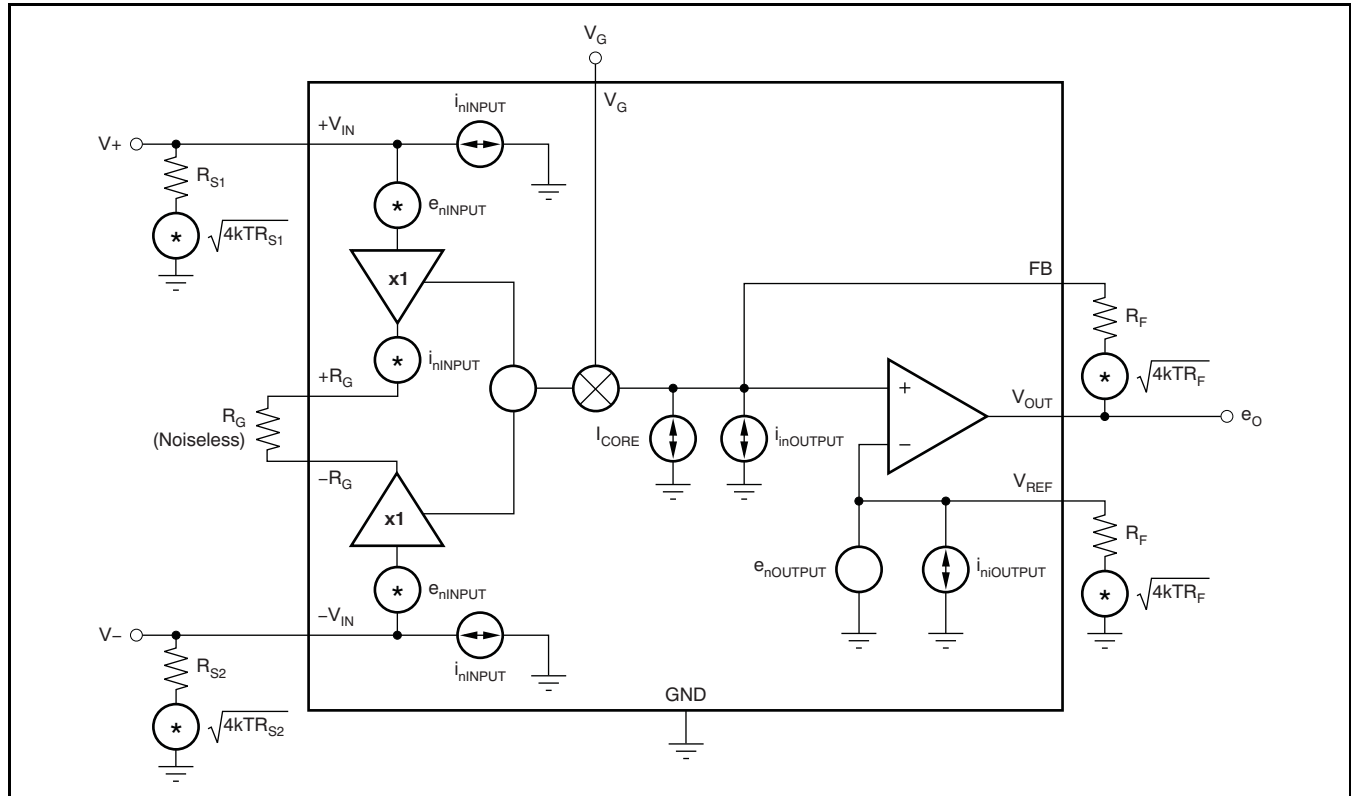

Figure 93. Full Noise Model

THERMAL ANALYSIS

The VCA822 does not require heatsinking or airflow in most applications. The maximum desired junction temperature sets the maximum allowed internal power dissipation as described in this section. In no case should the maximum junction temperature be allowed to exceed +150°C.

Operating junction temperature (T_J) is given by Equation 12:

$$T_J = T_A + P_D \times \theta_{JA} \quad (12)$$

The total internal power dissipation (P_D) is the sum of quiescent power (P_{DQ}) and additional power dissipated in the output stage (P_{DL}) to deliver load power. Quiescent power is simply the specified no-load supply current times the total supply voltage across the part. P_{DL} depends on the required output signal and load; for a grounded resistive load,

however, it is at a maximum when the output is fixed at a voltage equal to one-half of either supply voltage (for equal bipolar supplies). Under this worst-case condition, $P_{DL} = V_S^2 / (4 \times R_L)$, where R_L is the resistive load.

Note that it is the power in the output stage and not in the load that determines internal power dissipation. As a worst-case example, compute the maximum T_J using a VCA822ID (SO-14 package) in the circuit of Figure 77 operating at maximum gain and at the maximum specified ambient temperature of +85°C.

$$P_D = 10V(38mA) + 5^2 / (4 \times 100\Omega) = 442.5mW \quad (13)$$

$$\text{Maximum } T_J = +85^\circ\text{C} + (0.449W \times 80^\circ\text{C/W}) = 120.5^\circ\text{C} \quad (14)$$

This maximum operating junction temperature is well below most system level targets. Most applications should be lower because an absolute worst-case output stage power was assumed in this calculation of $V_{CC}/2$, which is beyond the output voltage range for the VCA822.

BOARD LAYOUT

Achieving optimum performance with a high-frequency amplifier such as the VCA822 requires careful attention to printed circuit board (PCB) layout parasitics and external component types. Recommendations to optimize performance include:

a) Minimize parasitic capacitance to any ac ground for all of the signal I/O pins. This recommendation includes the ground pin (pin 2). Parasitic capacitance on the output can cause instability: on both the inverting input and the noninverting input, it can react with the source impedance to cause unintentional band limiting. To reduce unwanted capacitance, a window around the signal I/O pins should be opened in all of the ground and power planes around those pins. Otherwise, ground and power planes should be unbroken elsewhere on the board. Place a small series resistance (greater than 25Ω) with the input pin connected to ground to help decouple package parasitics.

b) Minimize the distance (less than 0.25") from the power-supply pins to high-frequency $0.1\mu\text{F}$ decoupling capacitors. At the device pins, the ground and power plane layout should not be in close proximity to the signal I/O pins. Avoid narrow power and ground traces to minimize inductance between the pins and the decoupling capacitors. The power-supply connections should always be decoupled with these capacitors. Larger ($2.2\mu\text{F}$ to $6.8\mu\text{F}$) decoupling capacitors, effective at lower frequencies, should also be used on the main supply pins. These capacitors may be placed somewhat farther from the device and may be shared among several devices in the same area of the PCB.

c) Careful selection and placement of external components preserve the high-frequency performance of the VCA822. Resistors should be a very low reactance type. Surface-mount resistors work best and allow a tighter overall layout. Metal-film and carbon composition, axially-leaded resistors can also provide good high-frequency performance. Again, keep the leads and PCB trace length as short as possible. Never use wire-wound type resistors in a high-frequency application. Because the output pin is the most sensitive to parasitic capacitance, always position the series output resistor, if any, as close as possible to the output pin. Other network components, such as inverting or non-inverting input termination resistors, should also be placed close to the package.

d) Connections to other wideband devices on the board may be made with short direct traces or through onboard transmission lines. For short connections, consider the trace and the input to the next device as a lumped capacitive load. Relatively wide traces (50mils to 100mils, or 1.27mm to 2.54mm) should be used, preferably with ground and power planes opened up around them.

e) Socketing a high-speed part like the VCA822 is not recommended. The additional lead length and pin-to-pin capacitance introduced by the socket can create an extremely troublesome parasitic network, which can make it almost impossible to achieve a smooth, stable frequency response. Best results are obtained by soldering the VCA822 onto the board.

INPUT AND ESD PROTECTION

The VCA822 is built using a very high-speed complementary bipolar process. The internal junction breakdown voltages are relatively low for these very small geometry devices. These breakdowns are reflected in the [Absolute Maximum Ratings](#) table.

All pins on the VCA822 are internally protected from ESD by means of a pair of back-to-back reverse-biased diodes to either power supply, as shown in [Figure 94](#). These diodes begin to conduct when the pin voltage exceeds either power supply by about 0.7V. This situation can occur with loss of the amplifier power supplies while a signal source is still present. The diodes can typically withstand a continuous current of 30mA without destruction. To ensure long-term reliability, however, diode current should be externally limited to 10mA whenever possible.

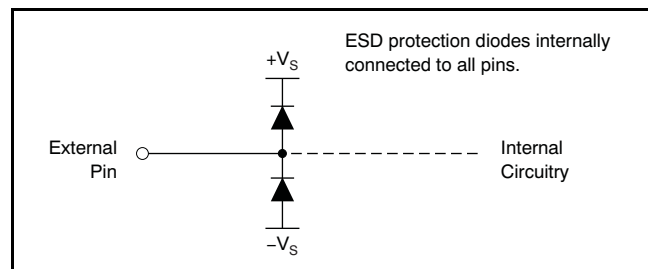

Figure 94. Internal ESD Protection

Revision History

Changes from Revision B (August 2008) to Revision C	Page
---	------

- Revised second paragraph in the *Wideband Variable Gain Amplifier Operation* section describing pin 9 19
-

Changes from Revision A (October 2007) to Revision B	Page
--	------

- Changed storage temperature range rating in *Absolute Maximum Ratings* table from -40°C to $+125^{\circ}\text{C}$ to -65°C to $+125^{\circ}\text{C}$ 2
-

PACKAGING INFORMATION

Orderable Device	Status ⁽¹⁾	Package Type	Package Drawing	Pins	Package Qty	Eco Plan ⁽²⁾	Lead/Ball Finish	MSL Peak Temp ⁽³⁾
VCA822ID	ACTIVE	SOIC	D	14	50	Green (RoHS & no Sb/Br)	CU NIPDAU	Level-2-260C-1 YEAR
VCA822IDG4	ACTIVE	SOIC	D	14	50	Green (RoHS & no Sb/Br)	CU NIPDAU	Level-2-260C-1 YEAR
VCA822IDGSR	ACTIVE	MSOP	DGS	10	2500	Green (RoHS & no Sb/Br)	CU NIPDAU	Level-2-260C-1 YEAR
VCA822IDGSRG4	ACTIVE	MSOP	DGS	10	2500	Green (RoHS & no Sb/Br)	CU NIPDAU	Level-2-260C-1 YEAR
VCA822IDGST	ACTIVE	MSOP	DGS	10	250	Green (RoHS & no Sb/Br)	CU NIPDAU	Level-2-260C-1 YEAR
VCA822IDGSTG4	ACTIVE	MSOP	DGS	10	250	Green (RoHS & no Sb/Br)	CU NIPDAU	Level-2-260C-1 YEAR
VCA822IDR	ACTIVE	SOIC	D	14	2500	Green (RoHS & no Sb/Br)	CU NIPDAU	Level-2-260C-1 YEAR
VCA822IDRG4	ACTIVE	SOIC	D	14	2500	Green (RoHS & no Sb/Br)	CU NIPDAU	Level-2-260C-1 YEAR

⁽¹⁾ The marketing status values are defined as follows:

ACTIVE: Product device recommended for new designs.

LIFEBUY: TI has announced that the device will be discontinued, and a lifetime-buy period is in effect.

NRND: Not recommended for new designs. Device is in production to support existing customers, but TI does not recommend using this part in a new design.

PREVIEW: Device has been announced but is not in production. Samples may or may not be available.

OBSOLETE: TI has discontinued the production of the device.

⁽²⁾ Eco Plan - The planned eco-friendly classification: Pb-Free (RoHS), Pb-Free (RoHS Exempt), or Green (RoHS & no Sb/Br) - please check <http://www.ti.com/productcontent> for the latest availability information and additional product content details.

TBD: The Pb-Free/Green conversion plan has not been defined.

Pb-Free (RoHS): TI's terms "Lead-Free" or "Pb-Free" mean semiconductor products that are compatible with the current RoHS requirements for all 6 substances, including the requirement that lead not exceed 0.1% by weight in homogeneous materials. Where designed to be soldered at high temperatures, TI Pb-Free products are suitable for use in specified lead-free processes.

Pb-Free (RoHS Exempt): This component has a RoHS exemption for either 1) lead-based flip-chip solder bumps used between the die and package, or 2) lead-based die adhesive used between the die and leadframe. The component is otherwise considered Pb-Free (RoHS compatible) as defined above.

Green (RoHS & no Sb/Br): TI defines "Green" to mean Pb-Free (RoHS compatible), and free of Bromine (Br) and Antimony (Sb) based flame retardants (Br or Sb do not exceed 0.1% by weight in homogeneous material)

⁽³⁾ MSL, Peak Temp. -- The Moisture Sensitivity Level rating according to the JEDEC industry standard classifications, and peak solder temperature.

Important Information and Disclaimer:The information provided on this page represents TI's knowledge and belief as of the date that it is provided. TI bases its knowledge and belief on information provided by third parties, and makes no representation or warranty as to the accuracy of such information. Efforts are underway to better integrate information from third parties. TI has taken and continues to take reasonable steps to provide representative and accurate information but may not have conducted destructive testing or chemical analysis on incoming materials and chemicals. TI and TI suppliers consider certain information to be proprietary, and thus CAS numbers and other limited information may not be available for release.

In no event shall TI's liability arising out of such information exceed the total purchase price of the TI part(s) at issue in this document sold by TI to Customer on an annual basis.

TAPE AND REEL INFORMATION
REEL DIMENSIONS

TAPE DIMENSIONS

A0	Dimension designed to accommodate the component width
B0	Dimension designed to accommodate the component length
K0	Dimension designed to accommodate the component thickness
W	Overall width of the carrier tape
P1	Pitch between successive cavity centers

TAPE AND REEL INFORMATION

*All dimensions are nominal

Device	Package Type	Package Drawing	Pins	SPQ	Reel Diameter (mm)	Reel Width W1 (mm)	A0 (mm)	B0 (mm)	K0 (mm)	P1 (mm)	W (mm)	Pin1 Quadrant
VCA822IDGSR	MSOP	DGS	10	2500	330.0	12.4	5.3	3.4	1.4	8.0	12.0	Q1
VCA822IDGST	MSOP	DGS	10	250	180.0	12.4	5.3	3.4	1.4	8.0	12.0	Q1
VCA822IDR	SOIC	D	14	2500	330.0	16.4	6.5	9.0	2.1	8.0	16.0	Q1

TAPE AND REEL BOX DIMENSIONS

*All dimensions are nominal

Device	Package Type	Package Drawing	Pins	SPQ	Length (mm)	Width (mm)	Height (mm)
VCA822IDGSR	MSOP	DGS	10	2500	367.0	367.0	35.0
VCA822IDGST	MSOP	DGS	10	250	210.0	185.0	35.0
VCA822IDR	SOIC	D	14	2500	367.0	367.0	38.0

DGS (S-PDSO-G10)

PLASTIC SMALL-OUTLINE PACKAGE



- NOTES:
- A. All linear dimensions are in millimeters.
 - B. This drawing is subject to change without notice.
 - C. Body dimensions do not include mold flash or protrusion.
 - D. Falls within JEDEC MO-187 variation BA.

D (R-PDSO-G14)

PLASTIC SMALL OUTLINE



- NOTES:
- A. All linear dimensions are in inches (millimeters).
 - B. This drawing is subject to change without notice.
 -  Body length does not include mold flash, protrusions, or gate burrs. Mold flash, protrusions, or gate burrs shall not exceed 0.006 (0,15) each side.
 -  Body width does not include interlead flash. Interlead flash shall not exceed 0.017 (0,43) each side.
 - E. Reference JEDEC MS-012 variation AB.

D (R-PDSO-G14)

PLASTIC SMALL OUTLINE



- NOTES:
- A. All linear dimensions are in millimeters.
 - B. This drawing is subject to change without notice.
 - C. Publication IPC-7351 is recommended for alternate designs.
 - D. Laser cutting apertures with trapezoidal walls and also rounding corners will offer better paste release. Customers should contact their board assembly site for stencil design recommendations. Refer to IPC-7525 for other stencil recommendations.
 - E. Customers should contact their board fabrication site for solder mask tolerances between and around signal pads.

IMPORTANT NOTICE

Texas Instruments Incorporated and its subsidiaries (TI) reserve the right to make corrections, enhancements, improvements and other changes to its semiconductor products and services per JESD46C and to discontinue any product or service per JESD48B. Buyers should obtain the latest relevant information before placing orders and should verify that such information is current and complete. All semiconductor products (also referred to herein as "components") are sold subject to TI's terms and conditions of sale supplied at the time of order acknowledgment.

TI warrants performance of its components to the specifications applicable at the time of sale, in accordance with the warranty in TI's terms and conditions of sale of semiconductor products. Testing and other quality control techniques are used to the extent TI deems necessary to support this warranty. Except where mandated by applicable law, testing of all parameters of each component is not necessarily performed.

TI assumes no liability for applications assistance or the design of Buyers' products. Buyers are responsible for their products and applications using TI components. To minimize the risks associated with Buyers' products and applications, Buyers should provide adequate design and operating safeguards.

TI does not warrant or represent that any license, either express or implied, is granted under any patent right, copyright, mask work right, or other intellectual property right relating to any combination, machine, or process in which TI components or services are used. Information published by TI regarding third-party products or services does not constitute a license to use such products or services or a warranty or endorsement thereof. Use of such information may require a license from a third party under the patents or other intellectual property of the third party, or a license from TI under the patents or other intellectual property of TI.

Reproduction of significant portions of TI information in TI data books or data sheets is permissible only if reproduction is without alteration and is accompanied by all associated warranties, conditions, limitations, and notices. TI is not responsible or liable for such altered documentation. Information of third parties may be subject to additional restrictions.

Resale of TI components or services with statements different from or beyond the parameters stated by TI for that component or service voids all express and any implied warranties for the associated TI component or service and is an unfair and deceptive business practice. TI is not responsible or liable for any such statements.

Buyer acknowledges and agrees that it is solely responsible for compliance with all legal, regulatory and safety-related requirements concerning its products, and any use of TI components in its applications, notwithstanding any applications-related information or support that may be provided by TI. Buyer represents and agrees that it has all the necessary expertise to create and implement safeguards which anticipate dangerous consequences of failures, monitor failures and their consequences, lessen the likelihood of failures that might cause harm and take appropriate remedial actions. Buyer will fully indemnify TI and its representatives against any damages arising out of the use of any TI components in safety-critical applications.

In some cases, TI components may be promoted specifically to facilitate safety-related applications. With such components, TI's goal is to help enable customers to design and create their own end-product solutions that meet applicable functional safety standards and requirements. Nonetheless, such components are subject to these terms.

No TI components are authorized for use in FDA Class III (or similar life-critical medical equipment) unless authorized officers of the parties have executed a special agreement specifically governing such use.

Only those TI components which TI has specifically designated as military grade or "enhanced plastic" are designed and intended for use in military/aerospace applications or environments. Buyer acknowledges and agrees that any military or aerospace use of TI components which have **not** been so designated is solely at the Buyer's risk, and that Buyer is solely responsible for compliance with all legal and regulatory requirements in connection with such use.

TI has specifically designated certain components which meet ISO/TS16949 requirements, mainly for automotive use. Components which have not been so designated are neither designed nor intended for automotive use; and TI will not be responsible for any failure of such components to meet such requirements.

Products

Audio	www.ti.com/audio
Amplifiers	amplifier.ti.com
Data Converters	dataconverter.ti.com
DLP® Products	www.dlp.com
DSP	dsp.ti.com
Clocks and Timers	www.ti.com/clocks
Interface	interface.ti.com
Logic	logic.ti.com
Power Mgmt	power.ti.com
Microcontrollers	microcontroller.ti.com
RFID	www.ti-rfid.com
OMAP Mobile Processors	www.ti.com/omap
Wireless Connectivity	www.ti.com/wirelessconnectivity

Applications

Automotive and Transportation	www.ti.com/automotive
Communications and Telecom	www.ti.com/communications
Computers and Peripherals	www.ti.com/computers
Consumer Electronics	www.ti.com/consumer-apps
Energy and Lighting	www.ti.com/energy
Industrial	www.ti.com/industrial
Medical	www.ti.com/medical
Security	www.ti.com/security
Space, Avionics and Defense	www.ti.com/space-avionics-defense
Video and Imaging	www.ti.com/video

TI E2E Community e2e.ti.com