

40-ns, microPOWER, Push-Pull Output Comparators

Check for Samples: [TLV3201](#), [TLV3202](#)

FEATURES

- **Low Propagation Delay: 40 ns**
- **Low Quiescent Current:**
40 μ A per Channel
- **Input Common-Mode Range Extends 200 mV Beyond Either Rail**
- **Low Input Offset Voltage: 1 mV**
- **Push-Pull Outputs**
- **Supply Range: +2.7 V to +5.5 V**
- **Industrial Temperature Range:**
–40°C to +125°C
- **Small Packages:**
SC70-5, SOT23-5, SOIC-8, MSOP-8

APPLICATIONS

- **Inspection Equipment**
- **Test and Measurement**
- **High-Speed Sampling Systems**
- **Telecom**
- **Portable Communications**

DESCRIPTION

The TLV3201 and TLV3202 are single- and dual-channel comparators that offer the ultimate combination of high-speed (40 ns) and low-power consumption (40 μ A), all in extremely small packages with features such as rail-to-rail inputs, low offset voltage (1 mV), and large output drive current. The devices are also very easy to implement in a wide variety of applications where response time is critical.

The TLV320x family is available in single (TLV3201) and dual (TLV3202) channel versions, both with push-pull outputs. The TLV3201 is available in SOT23-5 and SC70-5 packages. The TLV3202 is available in SOIC-8 and MSOP-8 packages. All devices are specified for operation across the expanded industrial temperature range of –40°C to +125°C.

RELATED PRODUCTS

DEVICE	DESCRIPTION
TLV3011	5- μ A (max) open-drain, 1.8-V to 5.5-V with integrated voltage reference in 1.5-mm x 1.5-mm micro-sized packages
TLV3012	5- μ A (max) push-pull, 1.8-V to 5.5-V with integrated voltage reference in micro-sized packages
TLV3501	4.5-ns, rail-to-rail, push-pull comparator in micro-sized packages
LMV7235	75-ns, 65- μ A, 2.7-V to 5.5-V, rail-to-rail input comparator with open-drain output
REF3333	30-ppm/°C drift, 3.9- μ A, SOT23-3, SC70-3 voltage reference

**D AND DGK PACKAGES
SOIC-8 AND MSOP-8
(TOP VIEW)**

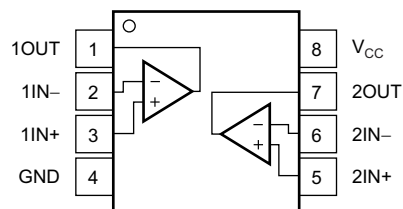

**DCK AND DBV PACKAGES
SC70-5 AND SOT23-5
(TOP VIEW)**

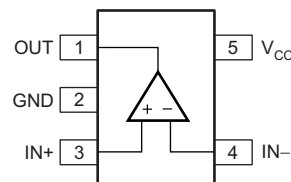

Please be aware that an important notice concerning availability, standard warranty, and use in critical applications of Texas Instruments semiconductor products and disclaimers thereto appears at the end of this data sheet.

All trademarks are the property of their respective owners.



This integrated circuit can be damaged by ESD. Texas Instruments recommends that all integrated circuits be handled with appropriate precautions. Failure to observe proper handling and installation procedures can cause damage.

ESD damage can range from subtle performance degradation to complete device failure. Precision integrated circuits may be more susceptible to damage because very small parametric changes could cause the device not to meet its published specifications.

PACKAGE ORDERING INFORMATION⁽¹⁾

PRODUCT	PACKAGE-LEAD ⁽²⁾	PACKAGE DESIGNATOR	PACKAGE MARKING	ORDERING NUMBER
TLV3201	SOT23-5	DBV	RAI	TLV3201AIDBV
	SC70-5	DCK	SDP	TLV3201AIDCK
TLV3202	SOIC-8	D	TL3202	TLV3202AID
	MSOP-8	DGK	VUDC	TLV3202AIDGK

- (1) For the most current package and ordering information, see the Package Option Addendum at the end of this document, or visit the device product folder at www.ti.com.
- (2) Package drawings, standard packing quantities, thermal data, symbolization, and printed circuit board (PCB) design guidelines are available at www.ti.com/sc/package.

ABSOLUTE MAXIMUM RATINGS⁽¹⁾

Over operating free-air temperature range, unless otherwise noted.

		VALUE	UNIT
Supply voltage		7	V
Signal input terminals	Voltage ⁽²⁾	-0.5 to (V _{CC}) + 0.5	V
	Current ⁽²⁾	±10	mA
Output short circuit ⁽³⁾		100	mA
Operating temperature range		-55 to +125	°C
Storage temperature range, T _{stg}		-65 to +150	°C
Junction temperature, T _J		+150	°C
Electrostatic discharge (ESD) ratings TLV3201	Human body model (HBM)	2000	V
Electrostatic discharge (ESD) ratings TLV3202	Human body model (HBM)	1000	V

- (1) Stresses beyond those listed under absolute maximum ratings may cause permanent damage to the device. These are stress ratings only, and functional operation of the device at these or any other conditions beyond those indicated under recommended operating conditions is not implied. Exposure to absolute-maximum-rated conditions for extended periods may affect device reliability.
- (2) All voltage values are with respect to the network ground terminal.
- (3) Short-circuit to ground.

ELECTRICAL CHARACTERISTICS: $V_{CC} = 5.0\text{ V}$

At $T_A = +25^\circ\text{C}$ and $V_{CC} = 5.0\text{ V}$, unless otherwise noted.

PARAMETER		TEST CONDITIONS	MIN	TYP	MAX	UNIT
OFFSET VOLTAGE						
V_{IO}	Input offset voltage	$V_{CM} = V_{CC} / 2$		1	5	mV
		$T_A = -40^\circ\text{C}$ to $+125^\circ\text{C}$			6	mV
dV_{OS}/dT	Input offset voltage drift	$T_A = -40^\circ\text{C}$ to $+125^\circ\text{C}$		1	10	$\mu\text{V}/^\circ\text{C}$
PSRR	Power-supply rejection ratio	$V_{CM} = V_{CC} / 2$, $V_{CC} = 2.5\text{ V}$ to 5.5 V	65	85		dB
	Input hysteresis			1.2		mV
INPUT BIAS CURRENT						
I_{IB}	Input bias current	$V_{CM} = V_{CC} / 2$		1	50	pA
		$T_A = -40^\circ\text{C}$ to $+125^\circ\text{C}$			5	nA
I_{IO}	Input offset current	$V_{CM} = V_{CC} / 2$		1	50	pA
		$T_A = -40^\circ\text{C}$ to $+125^\circ\text{C}$			2.5	nA
INPUT VOLTAGE RANGE						
V_{CM}	Common-mode voltage range	$T_A = -40^\circ\text{C}$ to $+125^\circ\text{C}$	$(V_{EE}) - 0.2$		$(V_{CC}) + 0.2$	V
CMRR	Common-mode rejection ratio	$-0.2\text{ V} < V_{CM} < 5.2\text{ V}$	60	70		dB
INPUT IMPEDANCE						
	Common-mode			$10^{13} \parallel 2$		$\Omega \parallel \text{pF}$
	Differential			$10^{13} \parallel 4$		$\Omega \parallel \text{pF}$
SWITCHING CHARACTERISTICS						
t_{pd}	Propagation delay time	Low to high	Input overdrive = 20 mV, $C_L = 15\text{ pF}$	47	50	ns
			Input overdrive = 100 mV, $C_L = 15\text{ pF}$	43	50	ns
			$T_A = -40^\circ\text{C}$ to $+125^\circ\text{C}$		55	ns
		High to low	Input overdrive = 20 mV, $C_L = 15\text{ pF}$	45	50	ns
			Input overdrive = 100 mV, $C_L = 15\text{ pF}$	42	50	ns
			$T_A = -40^\circ\text{C}$ to $+125^\circ\text{C}$		55	ns
	Propagation delay skew	Input overdrive = 20mV, $C_L = 15\text{ pF}$	2			ns
	Propagation delay matching (TLV3202)	High to low, Low to High	Input overdrive = 20 mV, $C_L = 15\text{ pF}$		5	ns
t_r	Rise time	10% to 90%		2.9		ns
t_f	Fall time	10% to 90%		3.7		ns
OUTPUT						
V_{OL}	Voltage output swing	From lower rail	$I_{SINK} = 4\text{ mA}$	175	190	mV
			$T_A = -40^\circ\text{C}$ to $+125^\circ\text{C}$		225	mV
From upper rail		$I_{SOURCE} = 4\text{ mA}$	120	140	mV	
		$T_A = -40^\circ\text{C}$ to $+125^\circ\text{C}$		170	mV	
I_{SC}	Short-circuit current (per comparator)	Sinking	I_{SC} sinking	40	48	mA
			$T_A = -40^\circ\text{C}$ to $+125^\circ\text{C}$		See Typical Curve	mA
		Sourcing	I_{SC} sourcing	52	60	mA
			$T_A = -40^\circ\text{C}$ to $+125^\circ\text{C}$		See Typical Curve	mA
POWER SUPPLY						
V_{CC}	Specified voltage		2.7		5.5	V
I_Q	Quiescent current			40	50	μA
		$T_A = -40^\circ\text{C}$ to $+125^\circ\text{C}$			65	μA
TEMPERATURE						
	Specified range		-40		+125	$^\circ\text{C}$
	Storage range		-65		+150	$^\circ\text{C}$

ELECTRICAL CHARACTERISTICS: $V_{CC} = 2.7\text{ V}$

At $T_A = +25^\circ\text{C}$ and $V_{CC} = 2.7\text{ V}$, unless otherwise noted.

PARAMETER		TEST CONDITIONS	MIN	TYP	MAX	UNIT
OFFSET VOLTAGE						
V_{IO}	Input offset voltage	$V_{CM} = V_{CC} / 2$		1	5	mV
		$T_A = -40^\circ\text{C}$ to $+125^\circ\text{C}$			6	mV
dV_{OS}/dT	Input offset voltage drift	$T_A = -40^\circ\text{C}$ to $+125^\circ\text{C}$		1	10	$\mu\text{V}/^\circ\text{C}$
PSRR	Power-supply rejection ratio	$V_{CM} = V_{CC} / 2$, $V_{CC} = 2.5\text{ V}$ to 5.5 V	65	85		dB
	Input hysteresis			1.2		mV
INPUT BIAS CURRENT						
I_{IB}	Input bias current	$V_{CM} = V_{CC} / 2$		1	50	pA
		$T_A = -40^\circ\text{C}$ to $+125^\circ\text{C}$			5	nA
I_{IO}	Input offset current	$V_{CM} = V_{CC} / 2$		1	50	pA
		$T_A = -40^\circ\text{C}$ to $+125^\circ\text{C}$			2.5	nA
INPUT VOLTAGE RANGE						
V_{CM}	Common-mode voltage range	$T_A = -40^\circ\text{C}$ to $+125^\circ\text{C}$	$(V_{EE}) - 0.2$		$(V_{CC}) + 0.2$	V
CMRR	Common-mode rejection ratio	$-0.2\text{ V} < V_{CM} < 2.9\text{ V}$	56	68		dB
INPUT IMPEDANCE						
	Common-mode			$10^{13} \parallel 2$		$\Omega \parallel \text{pF}$
	Differential			$10^{13} \parallel 4$		$\Omega \parallel \text{pF}$
SWITCHING CHARACTERISTICS						
t_{pd}	Propagation delay time	Low to high	Input overdrive = 20 mV, $C_L = 15\text{ pF}$	47	50	ns
			Input overdrive = 100 mV, $C_L = 15\text{ pF}$	42	50	ns
			$T_A = -40^\circ\text{C}$ to $+125^\circ\text{C}$		55	ns
		High to low	Input overdrive = 20 mV, $C_L = 15\text{ pF}$	40	50	ns
			Input overdrive = 100 mV, $C_L = 15\text{ pF}$	38	50	ns
			$T_A = -40^\circ\text{C}$ to $+125^\circ\text{C}$		55	ns
	Propagation delay skew	Input overdrive = 20mV, $C_L = 15\text{ pF}$	2			ns
	Propagation delay matching (TLV3202)	High to low, Low to High	Input overdrive = 20 mV, $C_L = 15\text{ pF}$		5	ns
t_r	Rise time	10% to 90%		4.8		ns
t_f	Fall time	10% to 90%		5.2		ns
OUTPUT						
V_{OL}	Voltage output swing	From lower rail	$I_{SINK} = 4\text{ mA}$	230	260	mV
			$T_A = -40^\circ\text{C}$ to $+125^\circ\text{C}$		325	mV
From upper rail		$I_{SOURCE} = 4\text{ mA}$	210	250	mV	
		$T_A = -40^\circ\text{C}$ to $+125^\circ\text{C}$		350	mV	
I_{SC}	Short-circuit current (per comparator)	Sinking	I_{SC} sinking	13	19	mA
			$T_A = -40^\circ\text{C}$ to $+125^\circ\text{C}$		See Typical Curve	mA
		Sourcing	I_{SC} sourcing	15	21	mA
			$T_A = -40^\circ\text{C}$ to $+125^\circ\text{C}$		See Typical Curve	mA
POWER SUPPLY						
V_{CC}	Specified voltage		2.7		5.5	V
I_Q	Quiescent current			36	46	μA
		$T_A = -40^\circ\text{C}$ to $+125^\circ\text{C}$			60	μA
TEMPERATURE						
	Specified range		-40		+125	$^\circ\text{C}$
	Storage range		-65		+150	$^\circ\text{C}$

THERMAL INFORMATION

THERMAL METRIC ⁽¹⁾		TLV3201		TLV3202		UNITS
		DBV (SOT23)	DCK (SC70)	D (SOIC)	DGK (MSOP)	
		5 PINS	5 PINS	8 PINS	8 PINS	
θ_{JA}	Junction-to-ambient thermal resistance	237.8	281.9	146.3	201.9	°C/W
θ_{JCTop}	Junction-to-case (top) thermal resistance	108.7	97.6	97.2	92.5	
θ_{JB}	Junction-to-board thermal resistance	64.1	68.3	84.2	123.3	
Ψ_{JT}	Junction-to-top characterization parameter	12.1	2.6	45.5	23.0	
Ψ_{JB}	Junction-to-board characterization parameter	63.3	67.3	83.7	121.6	
θ_{JCbott}	Junction-to-case (bottom) thermal resistance	N/A	N/A	N/A	N/A	

(1) For more information about traditional and new thermal metrics, see the *IC Package Thermal Metrics* application report, [SPRA953](http://sprae953).

PIN CONFIGURATIONS

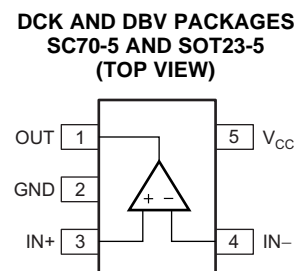
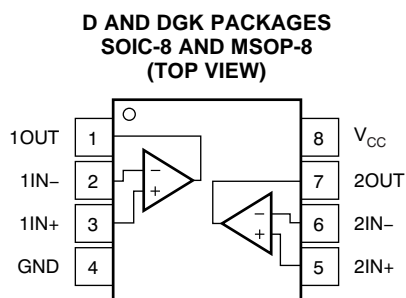

PIN DESCRIPTIONS: D, DGK

NAME	NO.	DESCRIPTION
1IN-	2	Negative input, comparator 1
1IN+	3	Positive input, comparator 1
1OUT	1	Output, comparator 1
2IN-	6	Negative input, comparator 2
2IN+	5	Positive input, comparator 2
2OUT	7	Output, comparator 2
GND	4	Negative supply, ground
V _{CC}	8	Positive supply

PIN DESCRIPTIONS: DCK, DBV

NAME	NO.	DESCRIPTION
OUT	1	Output
GND	2	Negative supply, ground
IN+	3	Positive input
V _{CC}	5	Positive supply
IN-	4	Negative input

TYPICAL CHARACTERISTICS

At $T_A = +25^\circ\text{C}$, $V_{CC} = +5\text{ V}$, and input overdrive (V_{OD}) = 20 mV, unless otherwise noted.

OFFSET VOLTAGE DISTRIBUTION

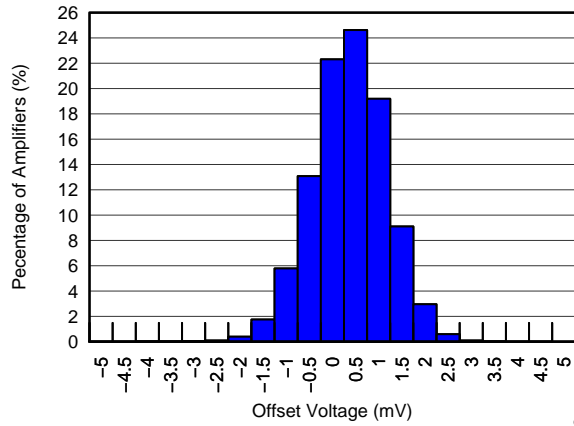

Figure 1.

G000

HYSTERESIS DISTRIBUTION

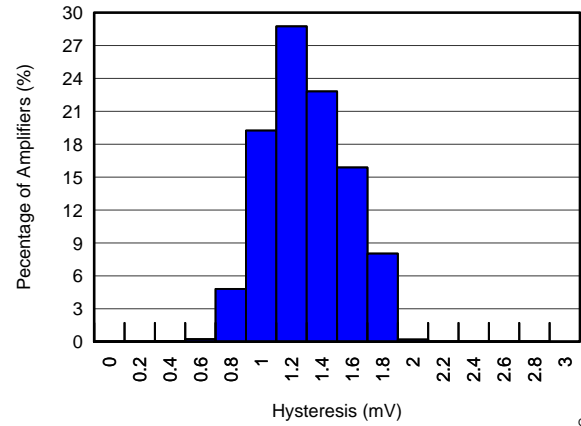

Figure 2.

G001

OFFSET VOLTAGE vs TEMPERATURE

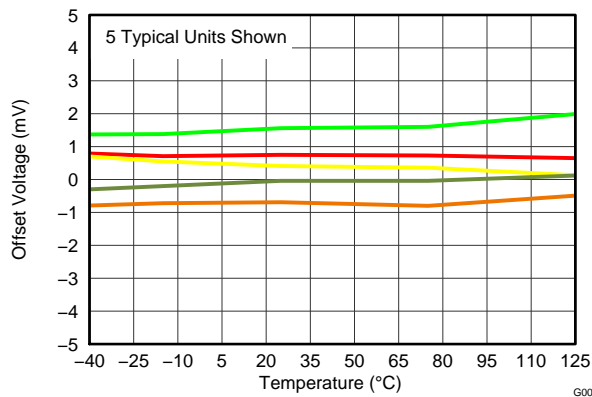

Figure 3.

G002

OFFSET VOLTAGE vs COMMON-MODE VOLTAGE

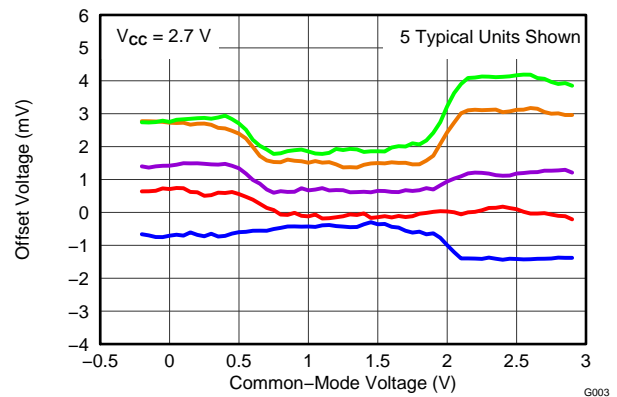

Figure 4.

G003

OFFSET VOLTAGE vs COMMON-MODE VOLTAGE

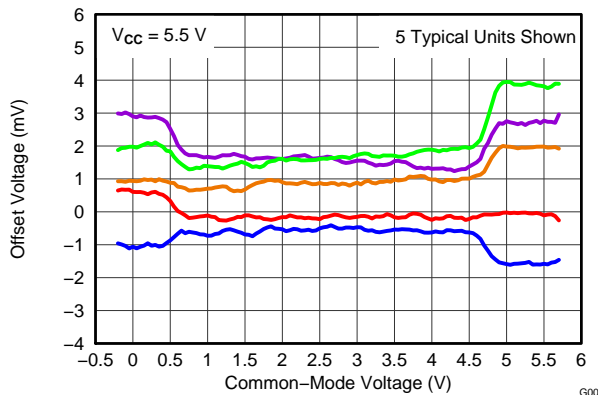

Figure 5.

G004

OFFSET VOLTAGE vs POWER SUPPLY

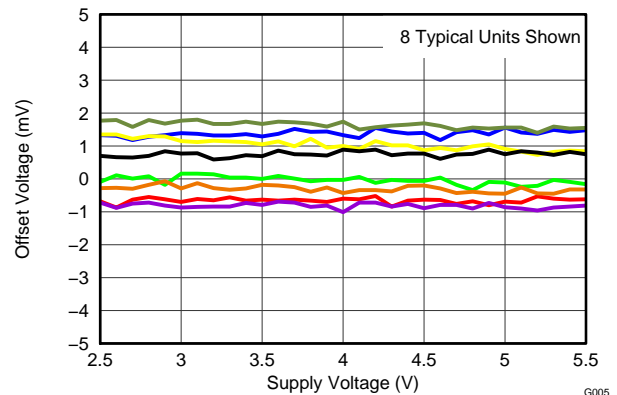

Figure 6.

G005

TYPICAL CHARACTERISTICS (continued)

At $T_A = +25^\circ\text{C}$, $V_{CC} = +5\text{ V}$, and input overdrive (V_{OD}) = 20 mV, unless otherwise noted.

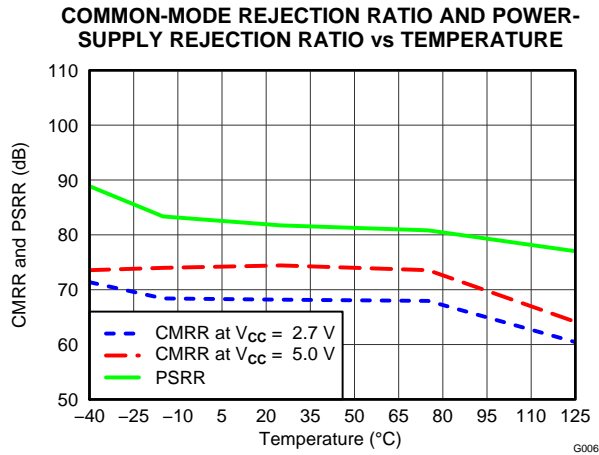

Figure 7.

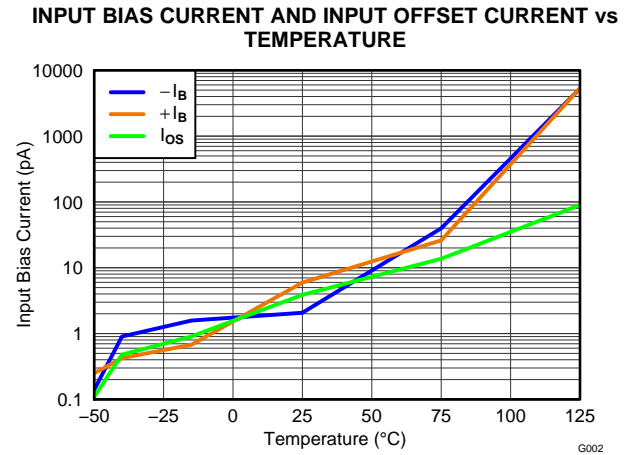

Figure 8.

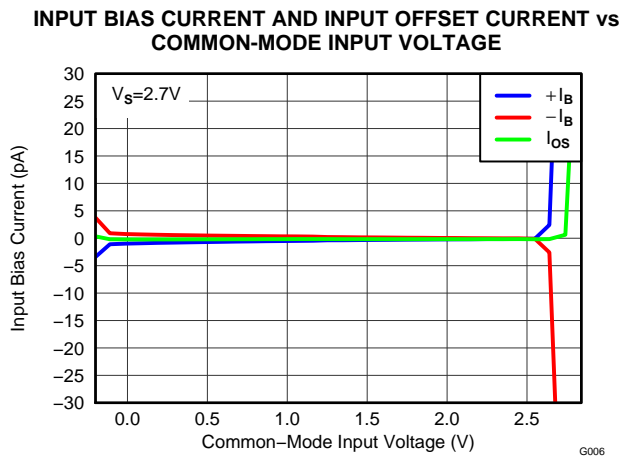

Figure 9.

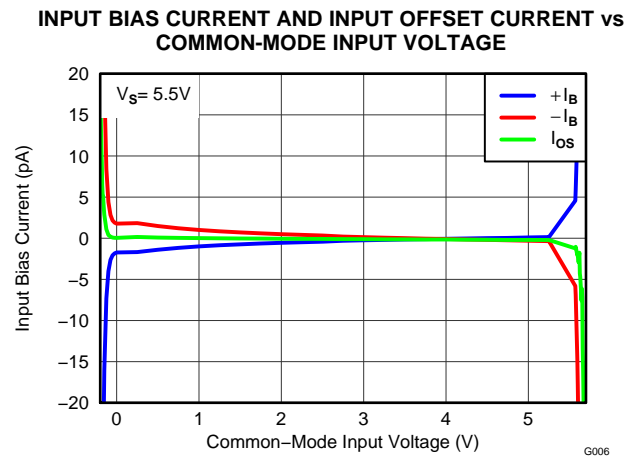

Figure 10.

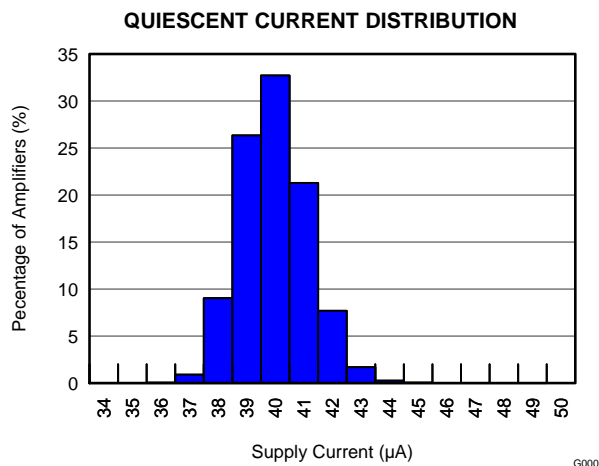

Figure 11.

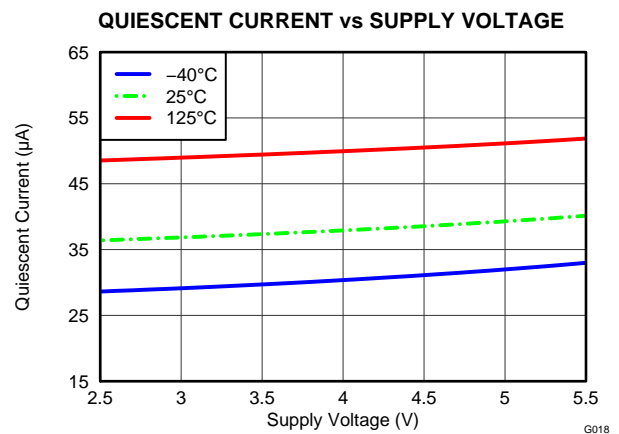

Figure 12.

TYPICAL CHARACTERISTICS (continued)

At $T_A = +25^\circ\text{C}$, $V_{CC} = +5\text{ V}$, and input overdrive (V_{OD}) = 20 mV, unless otherwise noted.

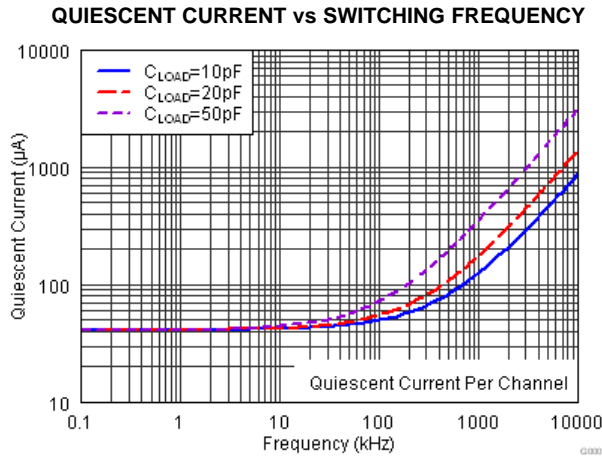

Figure 13.

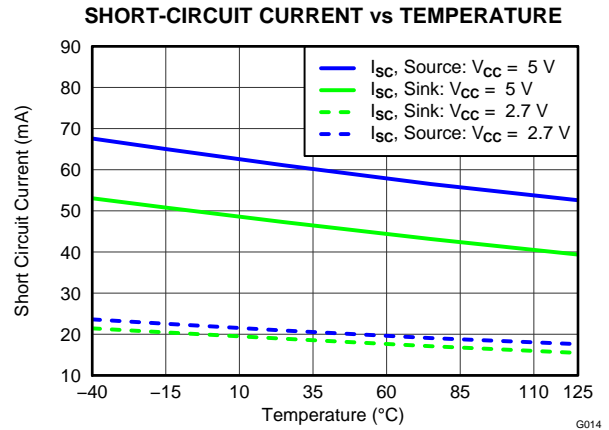

Figure 14.

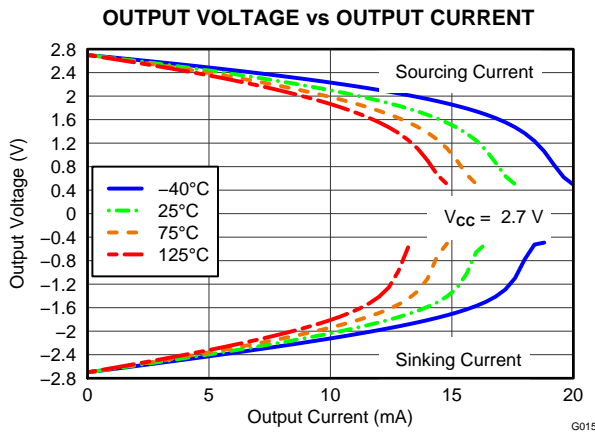

Figure 15.

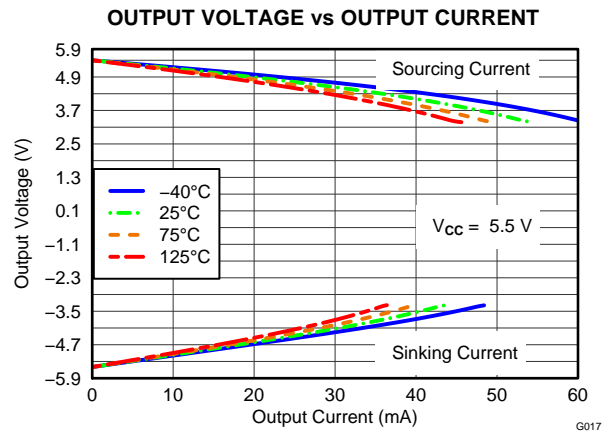

Figure 16.

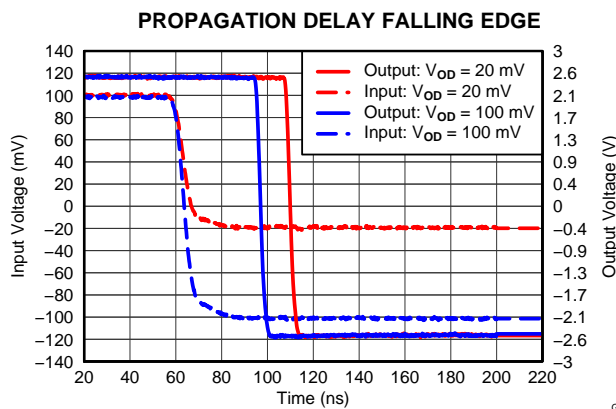

Figure 17.

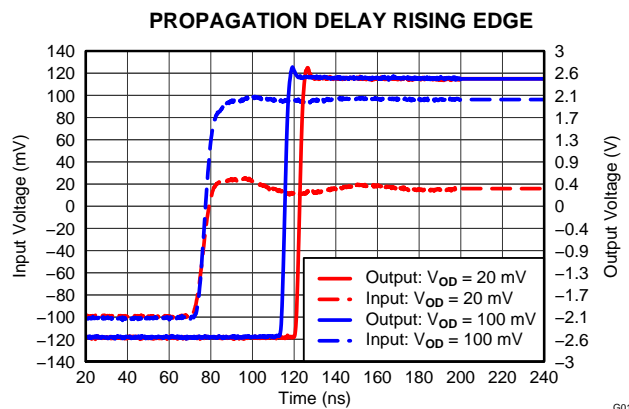

Figure 18.

TYPICAL CHARACTERISTICS (continued)

At $T_A = +25^\circ\text{C}$, $V_{CC} = +5\text{ V}$, and input overdrive (V_{OD}) = 20 mV, unless otherwise noted.

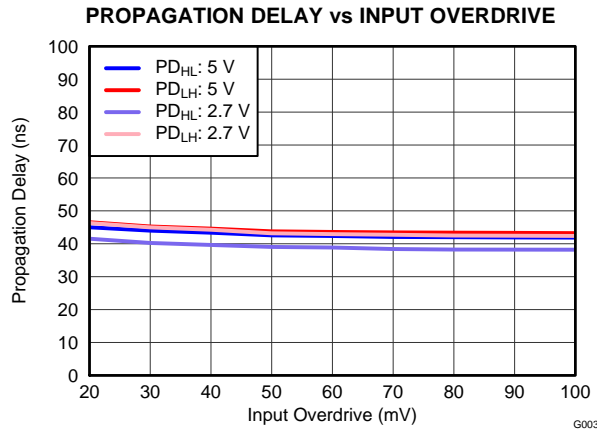

Figure 19.

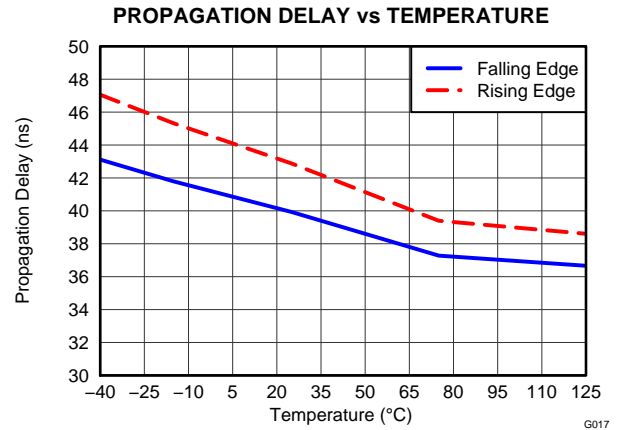

Figure 20.

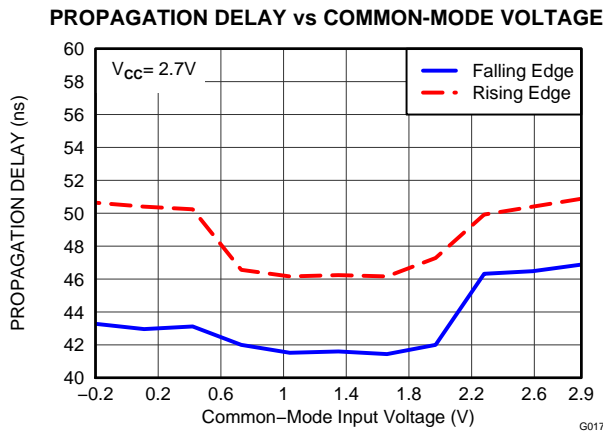

Figure 21.

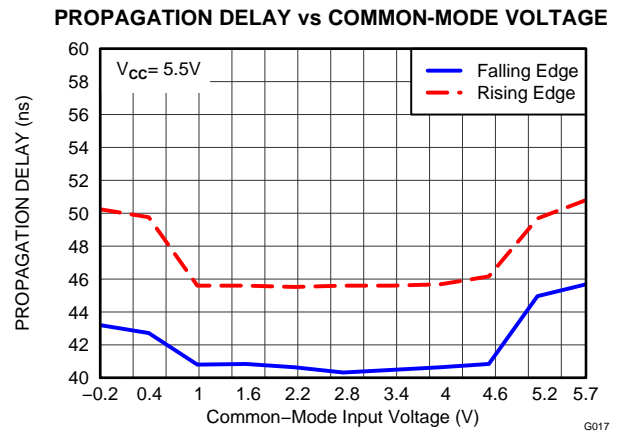

Figure 22.

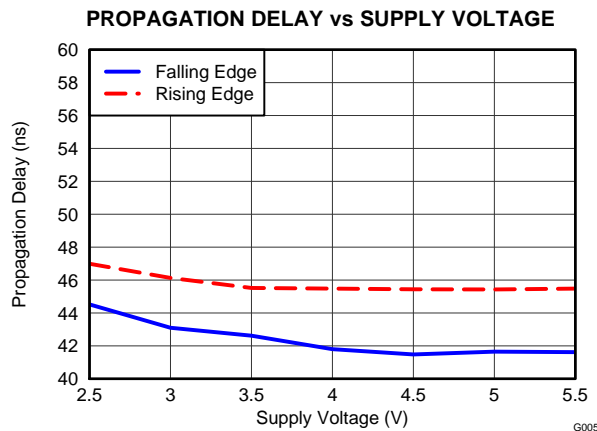

Figure 23.

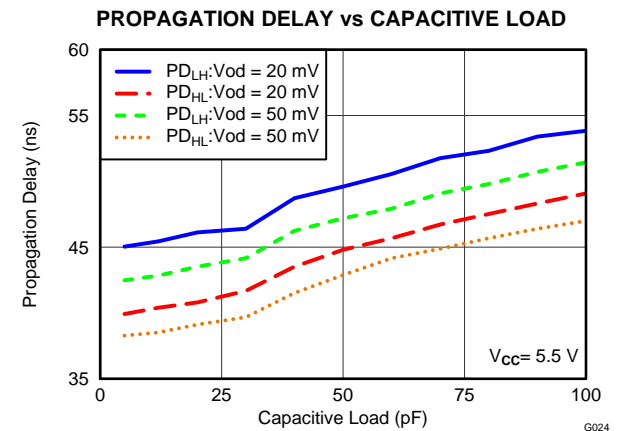

Figure 24.

APPLICATION INFORMATION

The TLV3201 and TLV3202 are single- and dual-supply (respectively), push-pull comparators featuring 40 ns of propagation delay on only 40 μ A of supply current. This combination of fast response time and minimal power consumption make the TLV3201 and TLV3202 excellent comparators for portable, battery-powered applications as well as fast-switching threshold detection such as pulse-width modulation (PWM) output monitors and zero-cross detection.

COMPARATOR INPUTS

The TLV3201 and TLV3202 are rail-to-rail input comparators, with an input common-mode range that exceeds the supply rails by 200 mV for both positive and negative supplies. The devices are specified from 2.7 V to 5.5 V, with room temperature operation from 2.5 V to 5.5 V. The TLV3201 and TLV3202 are designed to prevent phase inversion when the input pins exceed the supply voltage. Figure 25 shows the TLV320x response when input voltages exceed the supply, resulting in no phase inversion.

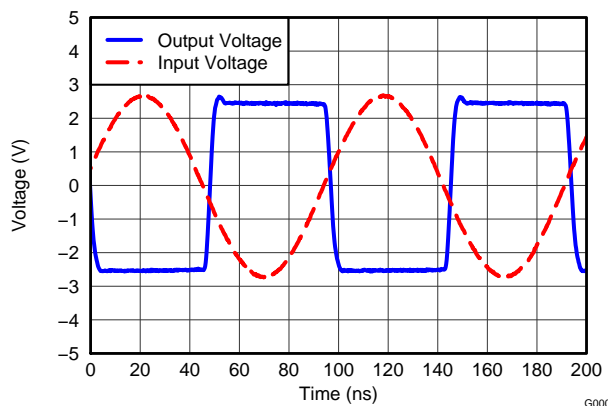

Figure 25. No Phase Inversion: Comparator Response to Input Voltage (Prop Delay Included)

The electrostatic discharge (ESD) protection input structure of two back-to-back diodes and 1-k Ω series resistors are used to limit the differential input voltage applied to the precision input of the comparator by clamping input voltages that exceed V_{CC} beyond the specified operating conditions. If potential overvoltage conditions that exceed absolute maximum ratings are present, the addition of external bypass diodes and resistors is recommended, as shown in Figure 26. Large differential voltages greater than the supply voltage should be avoided to prevent damage to the input stage.

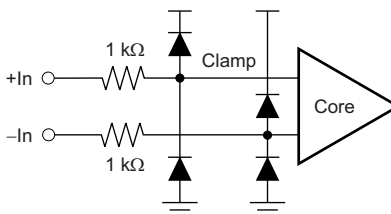

Figure 26. TLV3201 equivalent input structure

EXTERNAL HYSTERESIS

The TLV3201 and TLV3202 have a hysteresis transfer curve (shown in Figure 27) that is a function of the following three components:

- V_{TH} : the actual set voltage or threshold trip voltage
- V_{OS} : the internal offset voltage between V_{IN+} and V_{IN-} . This voltage is added to V_{TH} to form the actual trip point at which the comparator must respond in order to change output states.
- V_{HYST} : internal hysteresis (or trip window) that is designed to reduce comparator sensitivity to noise.

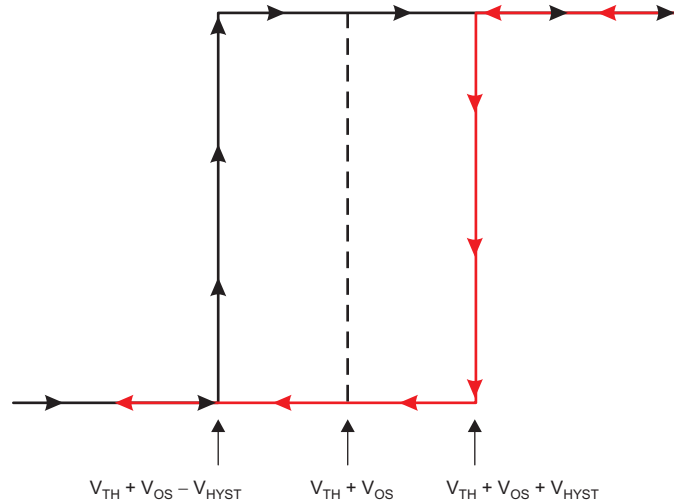

Figure 27. TLV3201 Hysteresis Transfer Curve

Inverting Comparator With Hysteresis

The inverting comparator with hysteresis requires a three-resistor network that is referenced to the comparator supply voltage (V_{CC}), as shown in [Figure 28](#). When V_{IN} at the inverting input is less than V_A , the output voltage is high (for simplicity assume V_O switches as high as V_{CC}). The three network resistors can be represented as $R1 \parallel R3$ in series with $R2$. The lower input trip voltage (V_{A1}) is defined by [Equation 1](#):

$$V_{A1} = V_{CC} \times \frac{R2}{(R1 \parallel R3) + R2} \quad (1)$$

When V_{IN} is greater than [$V_A \times (V_{IN} > V_A)$], the output voltage is low, very close to ground. In this case, the three network resistors can be presented as $R2 \parallel R3$ in series with $R1$. The upper trip voltage (V_{A2}) is defined by [Equation 2](#):

$$V_{A2} = V_{CC} \times \frac{R2 \parallel R3}{R1 + (R2 \parallel R3)} \quad (2)$$

The total hysteresis provided by the network is defined by [Equation 3](#):

$$\Delta V_A = V_{A1} - V_{A2} \quad (3)$$

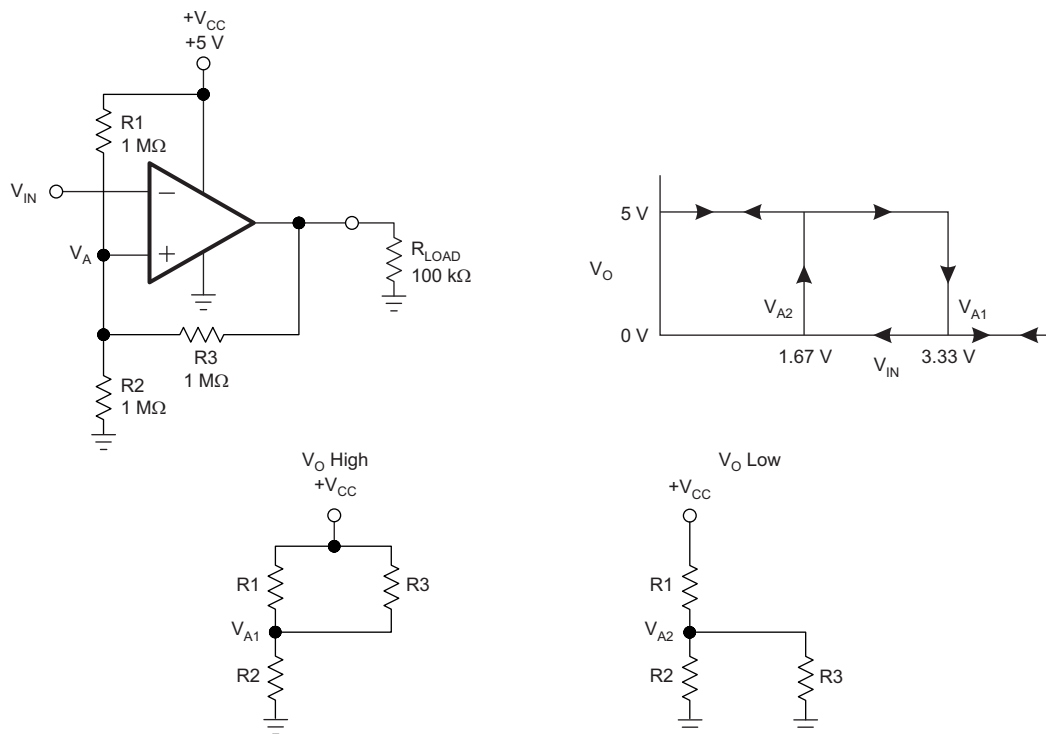

Figure 28. TLV3201 in Inverting Configuration with Hysteresis

Noninverting Comparator with Hysteresis

A noninverting comparator with hysteresis requires a two-resistor network, as shown in Figure 29, and a voltage reference (V_{REF}) at the inverting input. When V_{IN} is low, the output is also low. For the output to switch from low to high, V_{IN} must rise up to V_{IN1} . V_{IN1} is calculated by Equation 4:

$$V_{IN1} = R1 \times \frac{V_{REF}}{R2} \times V_{REF} \quad (4)$$

When V_{IN} is high, the output is also high. In order for the comparator to switch back to a low state, V_{IN} must equal V_{REF} before V_A is again equal to V_{REF} . V_{IN} can be calculated by Equation 5:

$$V_{IN2} = \frac{V_{REF} (R1 + R2) - V_{CC} \times R1}{R2} \quad (5)$$

The hysteresis of this circuit is the difference between V_{IN1} and V_{IN2} , as defined by Equation 6.

$$\Delta V_{IN} = V_{CC} \times \frac{R1}{R2} \quad (6)$$

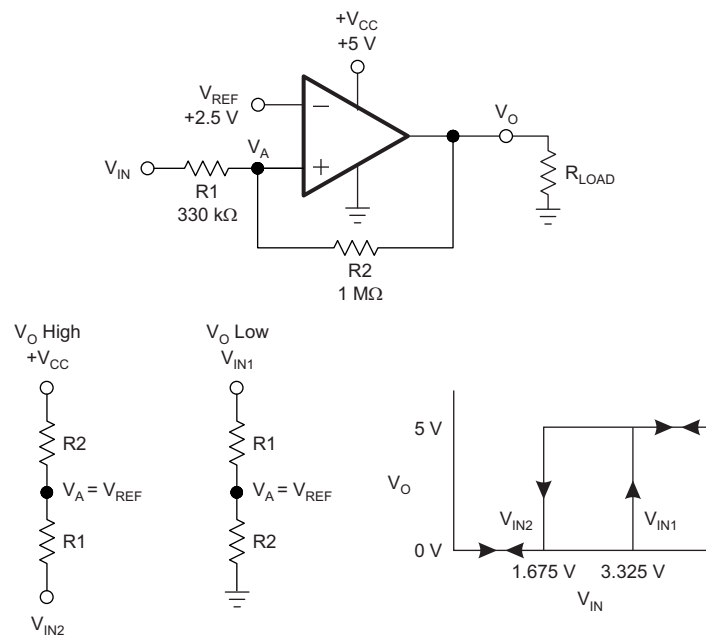

Figure 29. TLV3201 in Noninverting Configuration with Hysteresis

CAPACITIVE LOADS

The TLV3201 and TLV3202 feature a push-pull output. When the output switches, there is a direct path between V_{CC} and ground, causing increased output sinking or sourcing current during the transition. Following the transition the output current decreases and supply current returns to 40 μ A, thus maintaining low power consumption. Under reasonable capacitive loads, the TLV3201 and TLV3202 maintain specified propagation delay (see the Typical Characteristics), but excessive capacitive loading under high switching frequencies may increase supply current, propagation delay, or induce decreased slew rate.

CIRCUIT LAYOUT

The TLV3201 and TLV3202 are fast-switching, high-speed comparators and require high-speed layout considerations. For best results, the following layout guidelines should be maintained:

1. Use a printed circuit board (PCB) with a good, unbroken low-inductance ground plane.
2. Place a decoupling capacitor (0.1- μF ceramic, surface-mount capacitor) as close as possible to V_{CC} .
3. On the inputs and the output, keep lead lengths as short as possible to avoid unwanted parasitic feedback around the comparator. Keep inputs away from the output.
4. Solder the device directly to the PCB rather than using a socket.
5. For slow-moving input signals, take care to prevent parasitic feedback. A small capacitor (1000 pF or less) placed between the inputs can help eliminate oscillations in the transition region. This capacitor causes some degradation to propagation delay when the impedance is low. The topside ground plane runs between the output and inputs.
6. The ground pin ground trace runs under the device up to the bypass capacitor, shielding the inputs from the outputs.

APPLICATIONS CIRCUITS

One of the benefits of ac coupling a single-supply comparator circuit is that it can block dc offsets induced by ground-loop offsets that could potentially produce either a false trip or a common-mode input violation. [Figure 30](#) shows the TLV3201 configured as an ac-coupled comparator.

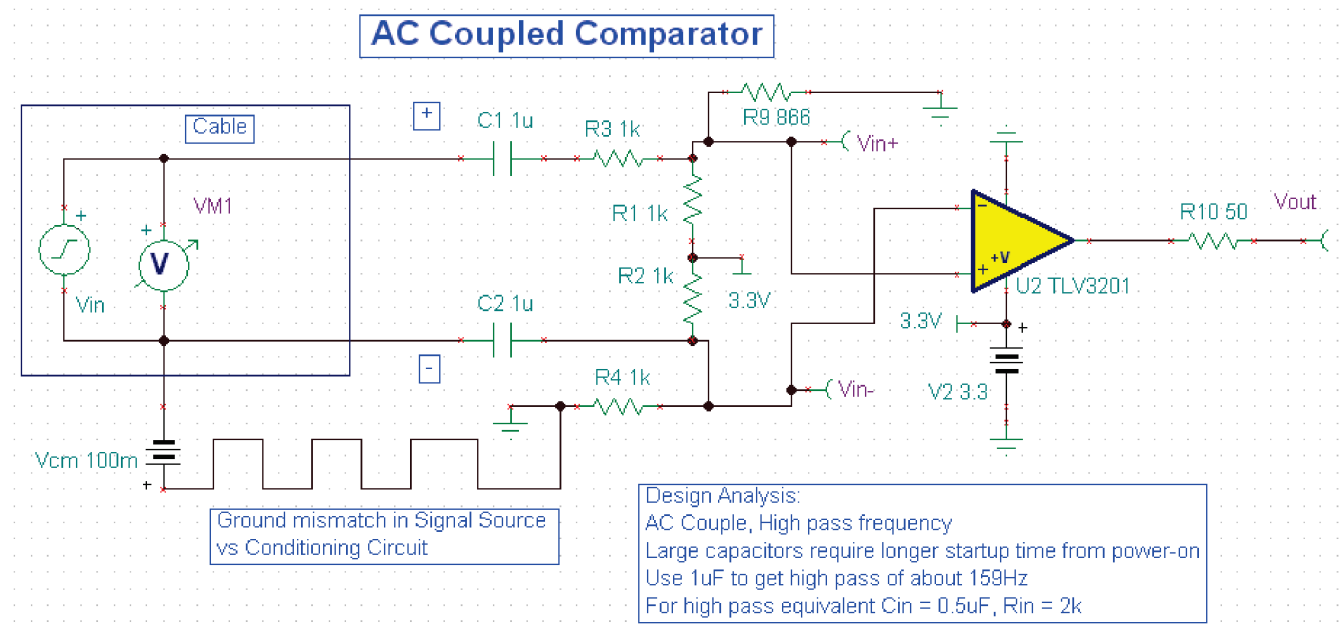

Figure 30. TLV3201 Configured as an AC-Coupled Comparator

Figure 31 shows a single-supply current monitor configured as a difference amplifier with a gain of 50. The OPA320 was chosen for this circuit because of its gain bandwidth (20 MHz), which allows higher speed triggering and monitoring of the current across the shunt resistor followed by the fast response of the TLV3201.

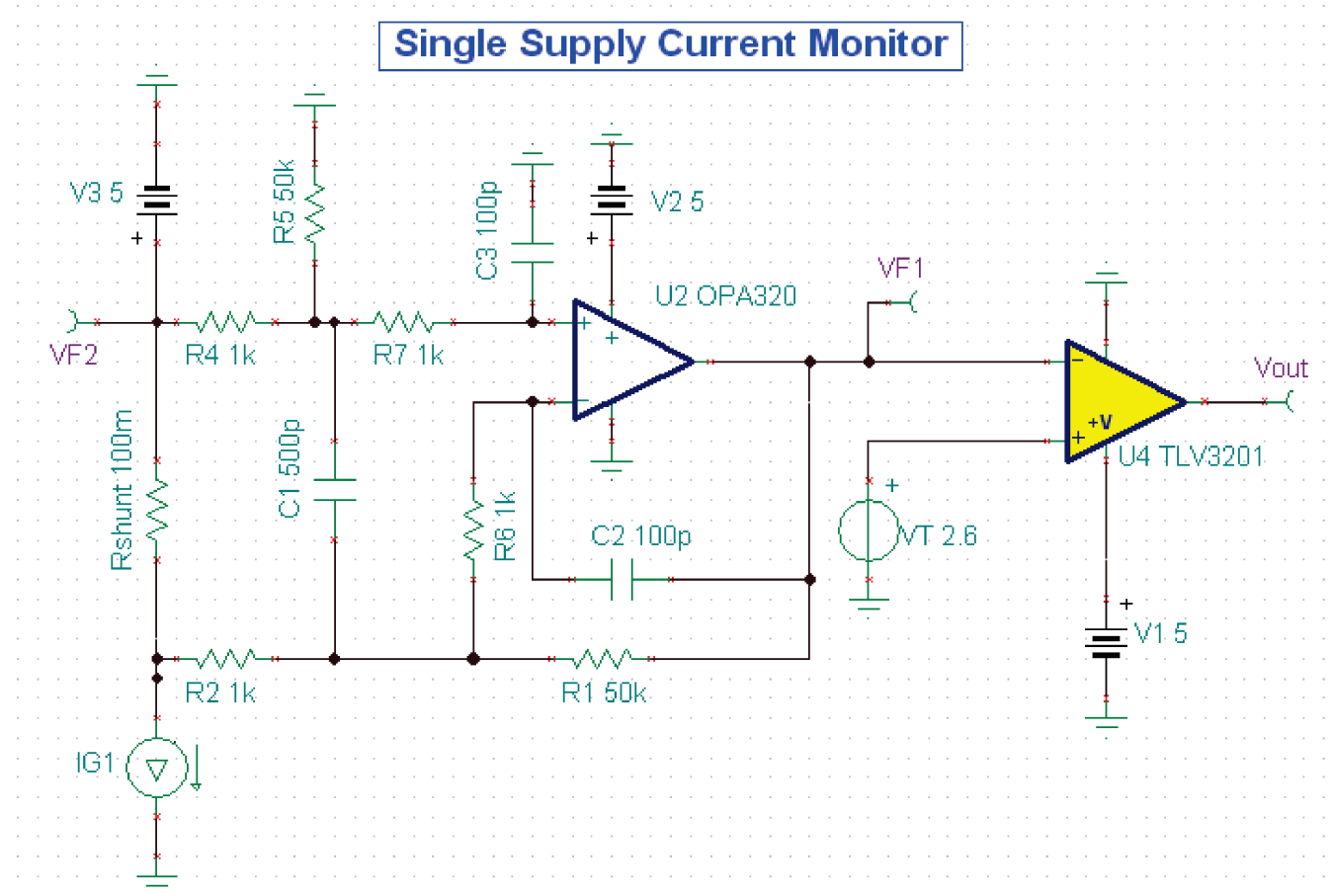

Figure 31. TLV3201 and OPA320 Configured as a Fast-Response Output Current Monitor

Figure 32 shows the TMP20 and TLV3201 designed as a high-speed temperature switch. The TMP20 is an analog output temperature sensor where output voltage decreases with temperature. The comparator output is tripped when the output reaches a critical trip threshold.

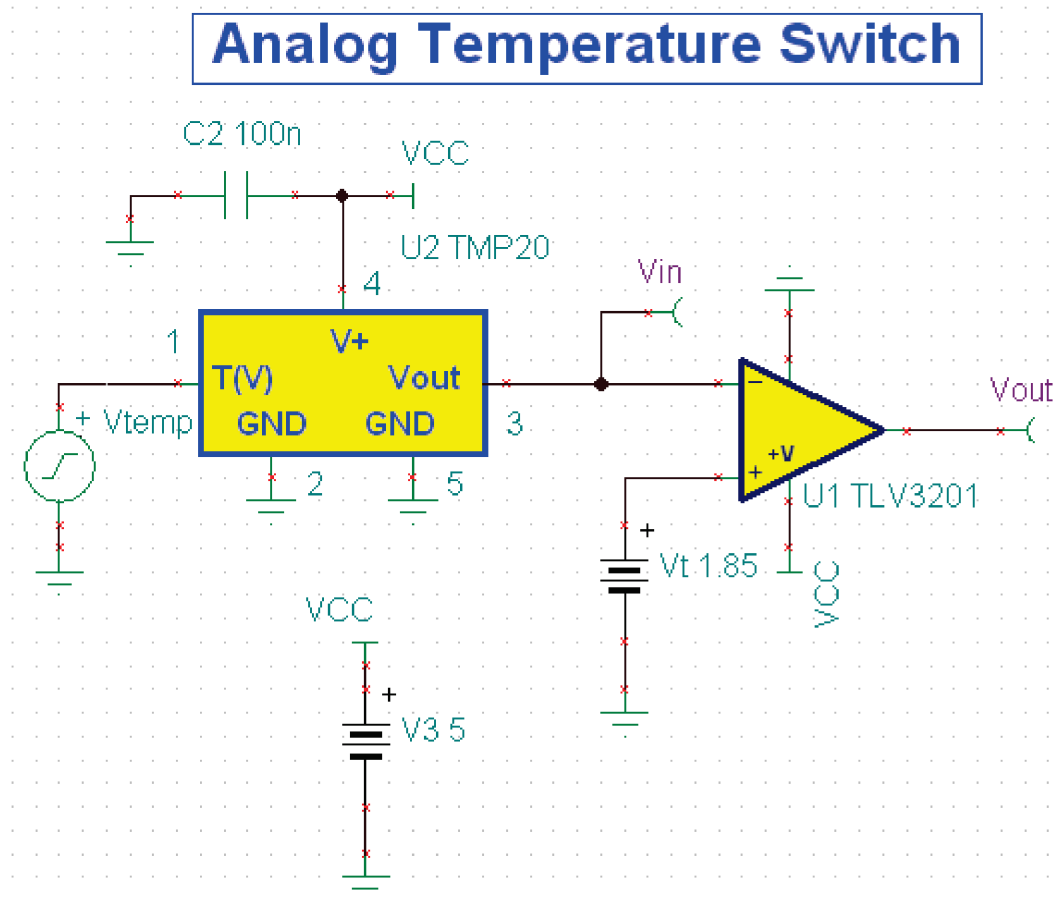

Figure 32. TLV3201 and TMP20 Configured as a Precision Analog Temperature Switch

REVISION HISTORY

NOTE: Page numbers for previous revisions may differ from page numbers in the current version.

Changes from Original (March 2012) to Revision A	Page
• Changed product status from Production Data to Mixed Status	1
• Added dual channel device	1

PACKAGING INFORMATION

Orderable Device	Status (1)	Package Type	Package Drawing	Pins	Package Qty	Eco Plan (2)	Lead/Ball Finish	MSL Peak Temp (3)	Op Temp (°C)	Top-Side Markings (4)	Samples
TLV3201AIDBVR	ACTIVE	SOT-23	DBV	5	3000	Green (RoHS & no Sb/Br)	CU NIPDAU	Level-2-260C-1 YEAR	-40 to 125	RAI	Samples
TLV3201AIDBVT	ACTIVE	SOT-23	DBV	5	250	Green (RoHS & no Sb/Br)	CU NIPDAU	Level-2-260C-1 YEAR	-40 to 125	RAI	Samples
TLV3201AIDCKR	ACTIVE	SC70	DCK	5	3000	Green (RoHS & no Sb/Br)	CU NIPDAU	Level-2-260C-1 YEAR	-40 to 125	SDP	Samples
TLV3201AIDCKT	ACTIVE	SC70	DCK	5	250	Green (RoHS & no Sb/Br)	CU NIPDAU	Level-2-260C-1 YEAR	-40 to 125	SDP	Samples
TLV3202AID	ACTIVE	SOIC	D	8	50	Green (RoHS & no Sb/Br)	CU NIPDAU	Level-2-260C-1 YEAR	-40 to 125	TL3202	Samples
TLV3202AIDGK	ACTIVE	VSSOP	DGK	8	80	Green (RoHS & no Sb/Br)	CU NIPDAUAG	Level-1-260C-UNLIM	-40 to 125	VUDC	Samples
TLV3202AIDGKR	ACTIVE	VSSOP	DGK	8	2500	Green (RoHS & no Sb/Br)	CU NIPDAUAG	Level-1-260C-UNLIM	-40 to 125	VUDC	Samples
TLV3202AIDR	ACTIVE	SOIC	D	8	2500	Green (RoHS & no Sb/Br)	CU NIPDAU	Level-2-260C-1 YEAR	-40 to 125	TL3202	Samples

(1) The marketing status values are defined as follows:

ACTIVE: Product device recommended for new designs.

LIFEBUY: TI has announced that the device will be discontinued, and a lifetime-buy period is in effect.

NRND: Not recommended for new designs. Device is in production to support existing customers, but TI does not recommend using this part in a new design.

PREVIEW: Device has been announced but is not in production. Samples may or may not be available.

OBSOLETE: TI has discontinued the production of the device.

(2) Eco Plan - The planned eco-friendly classification: Pb-Free (RoHS), Pb-Free (RoHS Exempt), or Green (RoHS & no Sb/Br) - please check <http://www.ti.com/productcontent> for the latest availability information and additional product content details.

TBD: The Pb-Free/Green conversion plan has not been defined.

Pb-Free (RoHS): TI's terms "Lead-Free" or "Pb-Free" mean semiconductor products that are compatible with the current RoHS requirements for all 6 substances, including the requirement that lead not exceed 0.1% by weight in homogeneous materials. Where designed to be soldered at high temperatures, TI Pb-Free products are suitable for use in specified lead-free processes.

Pb-Free (RoHS Exempt): This component has a RoHS exemption for either 1) lead-based flip-chip solder bumps used between the die and package, or 2) lead-based die adhesive used between the die and leadframe. The component is otherwise considered Pb-Free (RoHS compatible) as defined above.

Green (RoHS & no Sb/Br): TI defines "Green" to mean Pb-Free (RoHS compatible), and free of Bromine (Br) and Antimony (Sb) based flame retardants (Br or Sb do not exceed 0.1% by weight in homogeneous material)

(3) MSL, Peak Temp. -- The Moisture Sensitivity Level rating according to the JEDEC industry standard classifications, and peak solder temperature.

⁽⁴⁾ Multiple Top-Side Markings will be inside parentheses. Only one Top-Side Marking contained in parentheses and separated by a "~" will appear on a device. If a line is indented then it is a continuation of the previous line and the two combined represent the entire Top-Side Marking for that device.

Important Information and Disclaimer: The information provided on this page represents TI's knowledge and belief as of the date that it is provided. TI bases its knowledge and belief on information provided by third parties, and makes no representation or warranty as to the accuracy of such information. Efforts are underway to better integrate information from third parties. TI has taken and continues to take reasonable steps to provide representative and accurate information but may not have conducted destructive testing or chemical analysis on incoming materials and chemicals. TI and TI suppliers consider certain information to be proprietary, and thus CAS numbers and other limited information may not be available for release.

In no event shall TI's liability arising out of such information exceed the total purchase price of the TI part(s) at issue in this document sold by TI to Customer on an annual basis.

TAPE AND REEL INFORMATION



QUADRANT ASSIGNMENTS FOR PIN 1 ORIENTATION IN TAPE



*All dimensions are nominal

Device	Package Type	Package Drawing	Pins	SPQ	Reel Diameter (mm)	Reel Width W1 (mm)	A0 (mm)	B0 (mm)	K0 (mm)	P1 (mm)	W (mm)	Pin1 Quadrant
TLV3201AIDBVR	SOT-23	DBV	5	3000	178.0	9.0	3.23	3.17	1.37	4.0	8.0	Q3
TLV3201AIDBVT	SOT-23	DBV	5	250	178.0	8.4	3.3	3.2	1.4	4.0	8.0	Q3
TLV3201AIDCKR	SC70	DCK	5	3000	178.0	9.0	2.4	2.5	1.2	4.0	8.0	Q3
TLV3201AIDCKT	SC70	DCK	5	250	178.0	8.4	2.4	2.5	1.2	4.0	8.0	Q3
TLV3202AIDGKR	VSSOP	DGK	8	2500	330.0	12.4	5.3	3.4	1.4	8.0	12.0	Q1
TLV3202AIDR	SOIC	D	8	2500	330.0	12.4	6.4	5.2	2.1	8.0	12.0	Q1

TAPE AND REEL BOX DIMENSIONS

*All dimensions are nominal

Device	Package Type	Package Drawing	Pins	SPQ	Length (mm)	Width (mm)	Height (mm)
TLV3201AIDBVR	SOT-23	DBV	5	3000	180.0	180.0	18.0
TLV3201AIDBVT	SOT-23	DBV	5	250	180.0	180.0	18.0
TLV3201AIDCKR	SC70	DCK	5	3000	190.0	190.0	30.0
TLV3201AIDCKT	SC70	DCK	5	250	190.0	190.0	30.0
TLV3202AIDGKR	VSSOP	DGK	8	2500	364.0	364.0	27.0
TLV3202AIDR	SOIC	D	8	2500	367.0	367.0	35.0

DBV (R-PDSO-G5)

PLASTIC SMALL-OUTLINE PACKAGE



- NOTES:
- All linear dimensions are in millimeters.
 - This drawing is subject to change without notice.
 - Body dimensions do not include mold flash or protrusion. Mold flash and protrusion shall not exceed 0.15 per side.
 - Falls within JEDEC MO-178 Variation AA.

DBV (R-PDSO-G5)

PLASTIC SMALL OUTLINE



- NOTES:
- A. All linear dimensions are in millimeters.
 - B. This drawing is subject to change without notice.
 - C. Customers should place a note on the circuit board fabrication drawing not to alter the center solder mask defined pad.
 - D. Publication IPC-7351 is recommended for alternate designs.
 - E. Laser cutting apertures with trapezoidal walls and also rounding corners will offer better paste release. Customers should contact their board assembly site for stencil design recommendations. Example stencil design based on a 50% volumetric metal load solder paste. Refer to IPC-7525 for other stencil recommendations.

DCK (R-PDSO-G5)

PLASTIC SMALL-OUTLINE PACKAGE



- NOTES:
- A. All linear dimensions are in millimeters.
 - B. This drawing is subject to change without notice.
 - C. Body dimensions do not include mold flash or protrusion. Mold flash and protrusion shall not exceed 0.15 per side.
 - D. Falls within JEDEC MO-203 variation AA.

DCK (R-PDSO-G5)

PLASTIC SMALL OUTLINE



- NOTES:
- A. All linear dimensions are in millimeters.
 - B. This drawing is subject to change without notice.
 - C. Customers should place a note on the circuit board fabrication drawing not to alter the center solder mask defined pad.
 - D. Publication IPC-7351 is recommended for alternate designs.
 - E. Laser cutting apertures with trapezoidal walls and also rounding corners will offer better paste release. Customers should contact their board assembly site for stencil design recommendations. Example stencil design based on a 50% volumetric metal load solder paste. Refer to IPC-7525 for other stencil recommendations.

DGK (S-PDSO-G8)

PLASTIC SMALL-OUTLINE PACKAGE

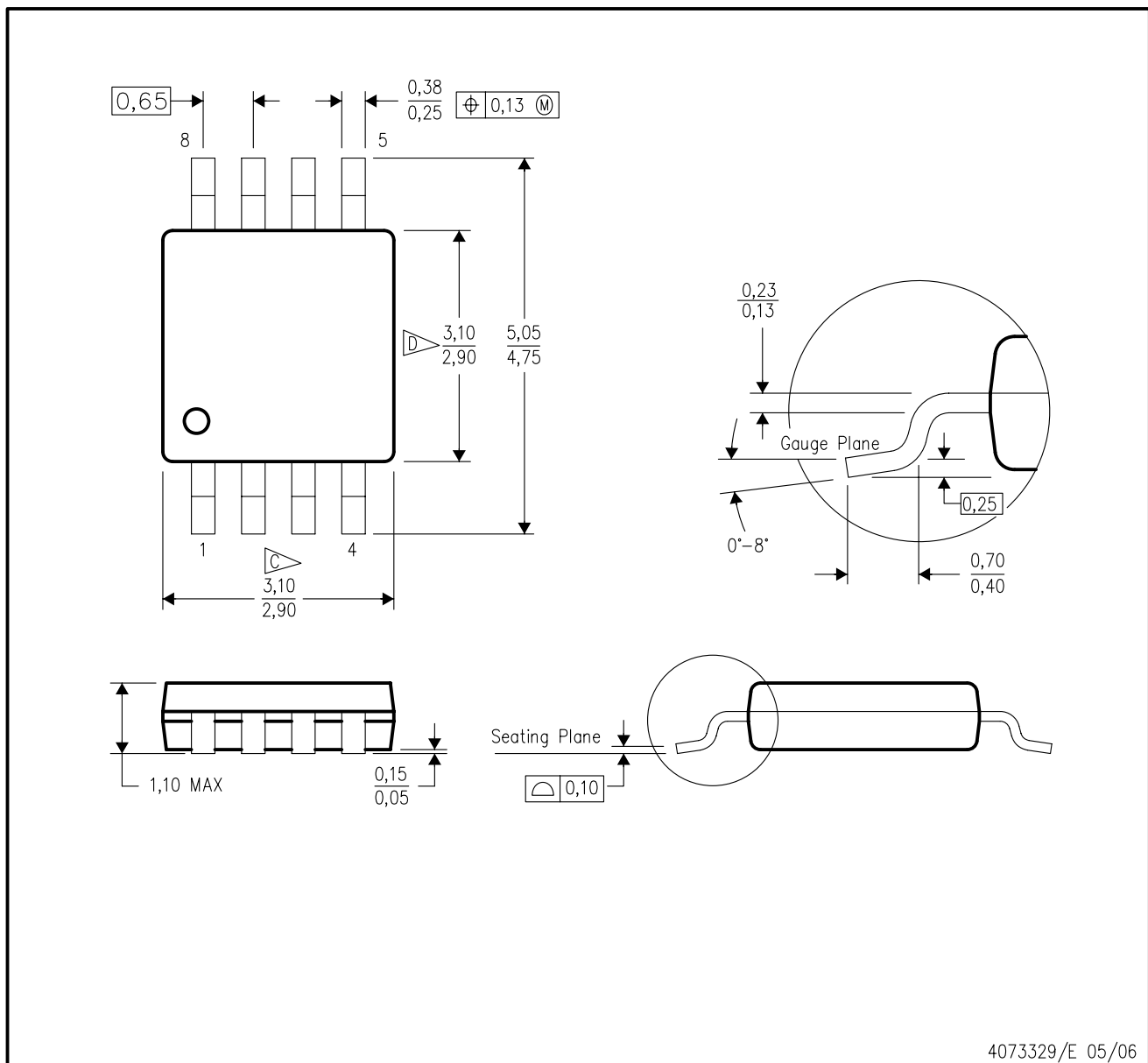

- NOTES:
- A. All linear dimensions are in millimeters.
 - B. This drawing is subject to change without notice.
 - C. Body length does not include mold flash, protrusions, or gate burrs. Mold flash, protrusions, or gate burrs shall not exceed 0.15 per end.
 - D. Body width does not include interlead flash. Interlead flash shall not exceed 0.50 per side.
 - E. Falls within JEDEC MO-187 variation AA, except interlead flash.



- NOTES:
- A. All linear dimensions are in millimeters.
 - B. This drawing is subject to change without notice.
 - C. Publication IPC-7351 is recommended for alternate designs.
 - D. Laser cutting apertures with trapezoidal walls and also rounding corners will offer better paste release. Customers should contact their board assembly site for stencil design recommendations. Refer to IPC-7525 for other stencil recommendations.
 - E. Customers should contact their board fabrication site for solder mask tolerances between and around signal pads.

D (R-PDSO-G8)

PLASTIC SMALL OUTLINE



- NOTES:
- A. All linear dimensions are in inches (millimeters).
 - B. This drawing is subject to change without notice.
 - C. Body length does not include mold flash, protrusions, or gate burrs. Mold flash, protrusions, or gate burrs shall not exceed 0.006 (0,15) each side.
 - D. Body width does not include interlead flash. Interlead flash shall not exceed 0.017 (0,43) each side.
 - E. Reference JEDEC MS-012 variation AA.

D (R-PDSO-G8)

PLASTIC SMALL OUTLINE



4211283-2/E 08/12

- NOTES:
- A. All linear dimensions are in millimeters.
 - B. This drawing is subject to change without notice.
 - C. Publication IPC-7351 is recommended for alternate designs.
 - D. Laser cutting apertures with trapezoidal walls and also rounding corners will offer better paste release. Customers should contact their board assembly site for stencil design recommendations. Refer to IPC-7525 for other stencil recommendations.
 - E. Customers should contact their board fabrication site for solder mask tolerances between and around signal pads.

IMPORTANT NOTICE

Texas Instruments Incorporated and its subsidiaries (TI) reserve the right to make corrections, enhancements, improvements and other changes to its semiconductor products and services per JESD46, latest issue, and to discontinue any product or service per JESD48, latest issue. Buyers should obtain the latest relevant information before placing orders and should verify that such information is current and complete. All semiconductor products (also referred to herein as "components") are sold subject to TI's terms and conditions of sale supplied at the time of order acknowledgment.

TI warrants performance of its components to the specifications applicable at the time of sale, in accordance with the warranty in TI's terms and conditions of sale of semiconductor products. Testing and other quality control techniques are used to the extent TI deems necessary to support this warranty. Except where mandated by applicable law, testing of all parameters of each component is not necessarily performed.

TI assumes no liability for applications assistance or the design of Buyers' products. Buyers are responsible for their products and applications using TI components. To minimize the risks associated with Buyers' products and applications, Buyers should provide adequate design and operating safeguards.

TI does not warrant or represent that any license, either express or implied, is granted under any patent right, copyright, mask work right, or other intellectual property right relating to any combination, machine, or process in which TI components or services are used. Information published by TI regarding third-party products or services does not constitute a license to use such products or services or a warranty or endorsement thereof. Use of such information may require a license from a third party under the patents or other intellectual property of the third party, or a license from TI under the patents or other intellectual property of TI.

Reproduction of significant portions of TI information in TI data books or data sheets is permissible only if reproduction is without alteration and is accompanied by all associated warranties, conditions, limitations, and notices. TI is not responsible or liable for such altered documentation. Information of third parties may be subject to additional restrictions.

Resale of TI components or services with statements different from or beyond the parameters stated by TI for that component or service voids all express and any implied warranties for the associated TI component or service and is an unfair and deceptive business practice. TI is not responsible or liable for any such statements.

Buyer acknowledges and agrees that it is solely responsible for compliance with all legal, regulatory and safety-related requirements concerning its products, and any use of TI components in its applications, notwithstanding any applications-related information or support that may be provided by TI. Buyer represents and agrees that it has all the necessary expertise to create and implement safeguards which anticipate dangerous consequences of failures, monitor failures and their consequences, lessen the likelihood of failures that might cause harm and take appropriate remedial actions. Buyer will fully indemnify TI and its representatives against any damages arising out of the use of any TI components in safety-critical applications.

In some cases, TI components may be promoted specifically to facilitate safety-related applications. With such components, TI's goal is to help enable customers to design and create their own end-product solutions that meet applicable functional safety standards and requirements. Nonetheless, such components are subject to these terms.

No TI components are authorized for use in FDA Class III (or similar life-critical medical equipment) unless authorized officers of the parties have executed a special agreement specifically governing such use.

Only those TI components which TI has specifically designated as military grade or "enhanced plastic" are designed and intended for use in military/aerospace applications or environments. Buyer acknowledges and agrees that any military or aerospace use of TI components which have **not** been so designated is solely at the Buyer's risk, and that Buyer is solely responsible for compliance with all legal and regulatory requirements in connection with such use.

TI has specifically designated certain components as meeting ISO/TS16949 requirements, mainly for automotive use. In any case of use of non-designated products, TI will not be responsible for any failure to meet ISO/TS16949.

Products

Audio	www.ti.com/audio
Amplifiers	amplifier.ti.com
Data Converters	dataconverter.ti.com
DLP® Products	www.dlp.com
DSP	dsp.ti.com
Clocks and Timers	www.ti.com/clocks
Interface	interface.ti.com
Logic	logic.ti.com
Power Mgmt	power.ti.com
Microcontrollers	microcontroller.ti.com
RFID	www.ti-rfid.com
OMAP Applications Processors	www.ti.com/omap
Wireless Connectivity	www.ti.com/wirelessconnectivity

Applications

Automotive and Transportation	www.ti.com/automotive
Communications and Telecom	www.ti.com/communications
Computers and Peripherals	www.ti.com/computers
Consumer Electronics	www.ti.com/consumer-apps
Energy and Lighting	www.ti.com/energy
Industrial	www.ti.com/industrial
Medical	www.ti.com/medical
Security	www.ti.com/security
Space, Avionics and Defense	www.ti.com/space-avionics-defense
Video and Imaging	www.ti.com/video

TI E2E Community

e2e.ti.com